



ASSEMBLY INSTRUCTIONS (VJ) MODEL NO. 502-515

Made in Vietnam

Thank you for purchasing this quality product. Be sure to check all packing material carefully for small parts which may have come loose inside the carton during shipment. Separate, identify, and count all parts and metal hardware. Compare with parts list and hardware illustrations to be sure all parts are present. If any parts are missing or damaged, phone, fax, or mail to Customer Service Department. For efficient and speedy service, please indicate the model number and code letter of part (s) needed

ATTENTION: SOME NUMBERED PARTS LISTED ON THE INSTRUCTION SHEET MAY NOT BE IN PARTS BAG AS THEY MAY ALREADY BE ASSEMBLED. CAREFULLY CHECK PARTS AND PACKING MATERIALS PRIOR TO ORDERING REPLACEMENTS

Tool Required : Allenkey (included)

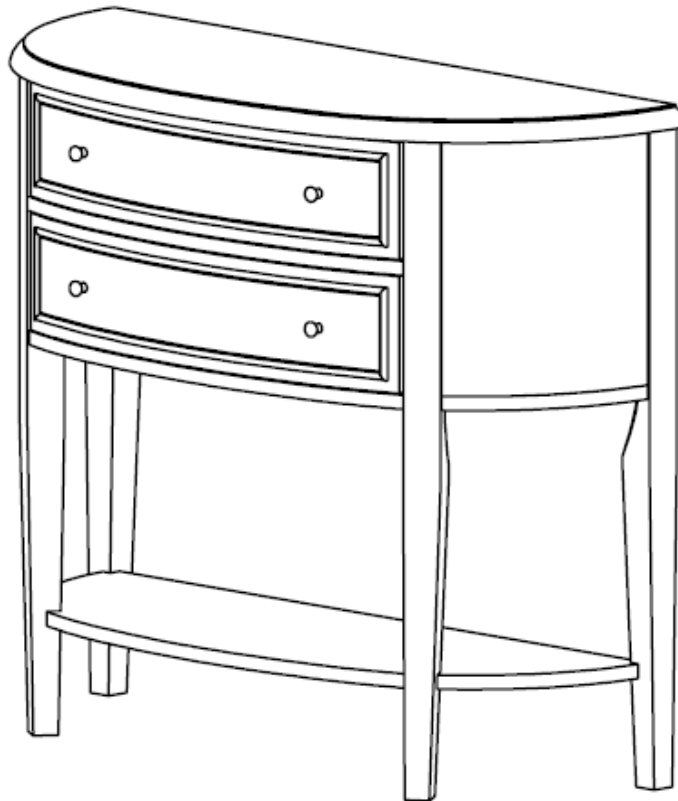

PARTS

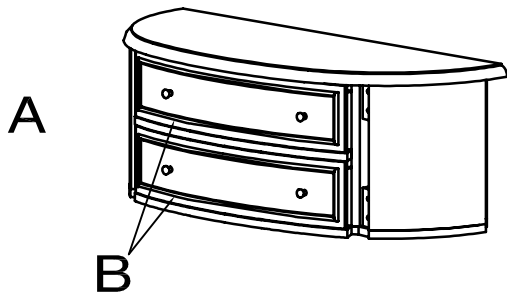

- A - TOP
- B - DRAWERS (2)
- C - LEGS (4)
- D - SHELF



HARDWARE

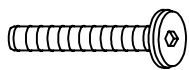

E
(16 PIECES)



F
(16 PIECES)



G
(16 PIECES)

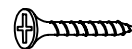

H
(4 PIECES)



I
(1 PIECE)

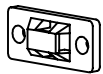

J
(2 PIECES)



K
(2 PIECES)

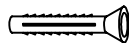

L
(2 PIECES)

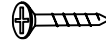

M
(2 PIECES)

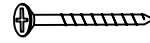

N
(2 PIECES)

STEP 1

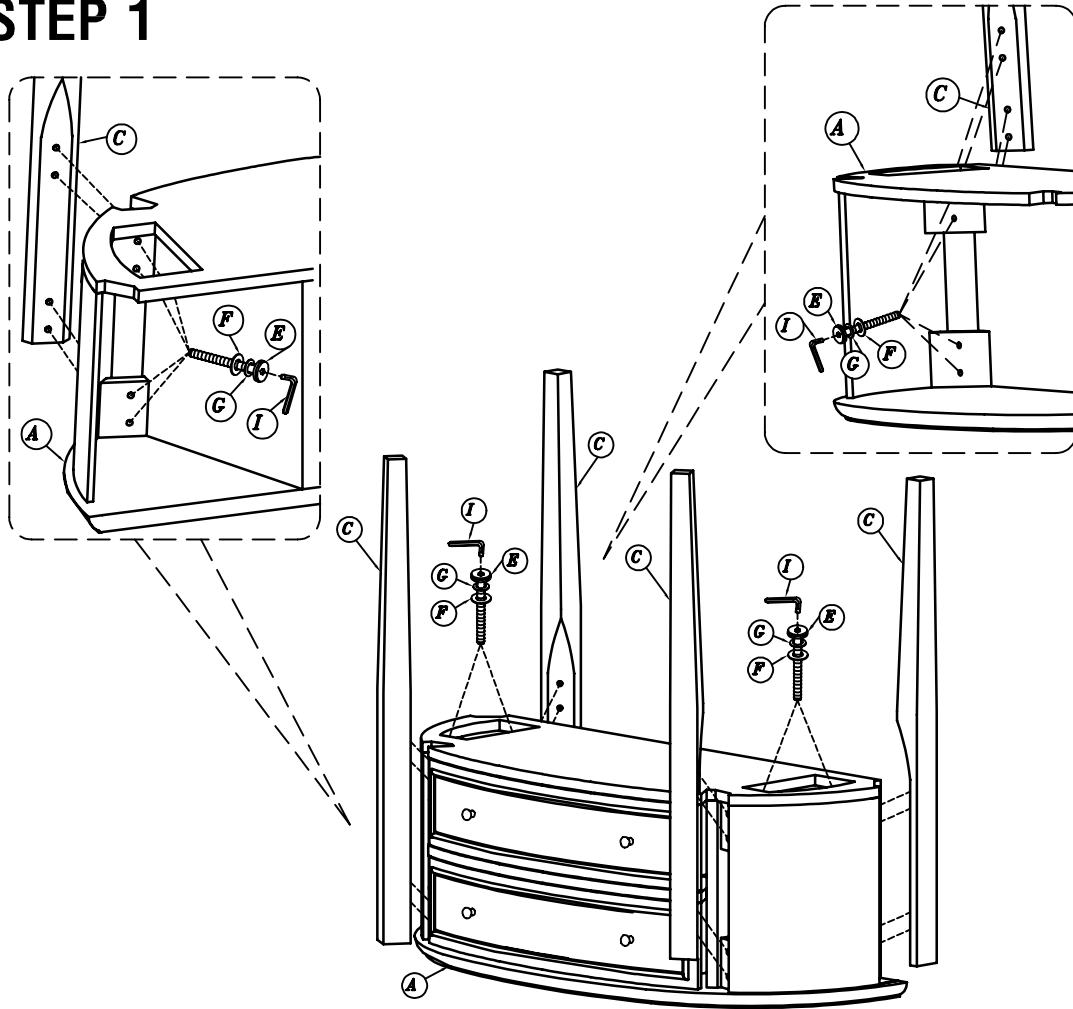

STEP 2

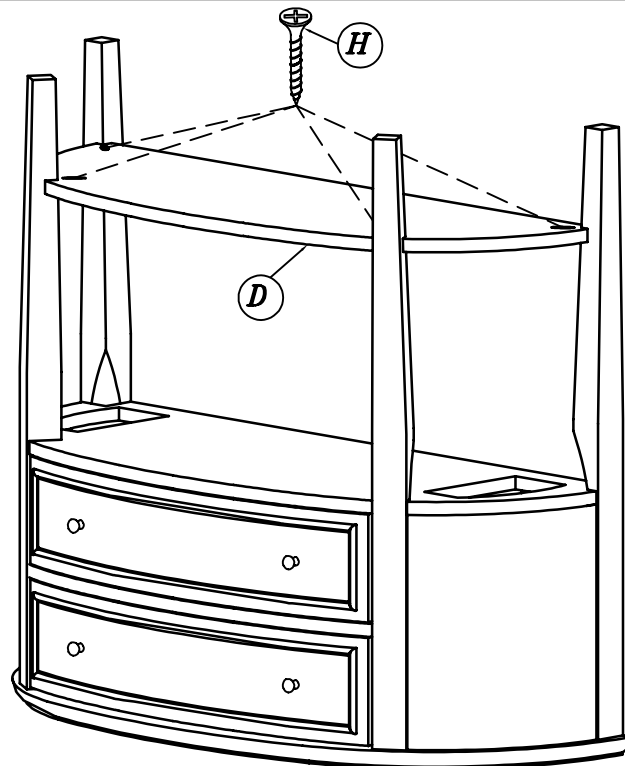

TO PREVENT TIP OVER, ATTACH UNIT TO A WALL

STEP 3

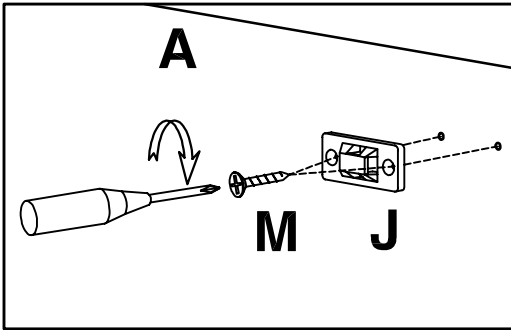

STEP 4

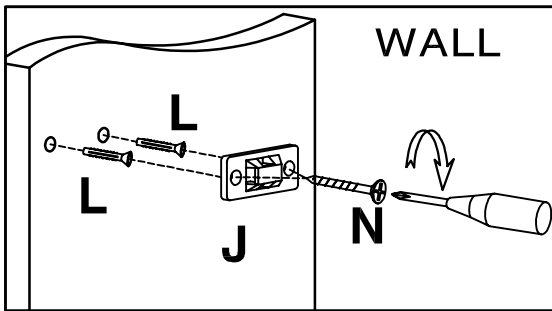

STEP 5

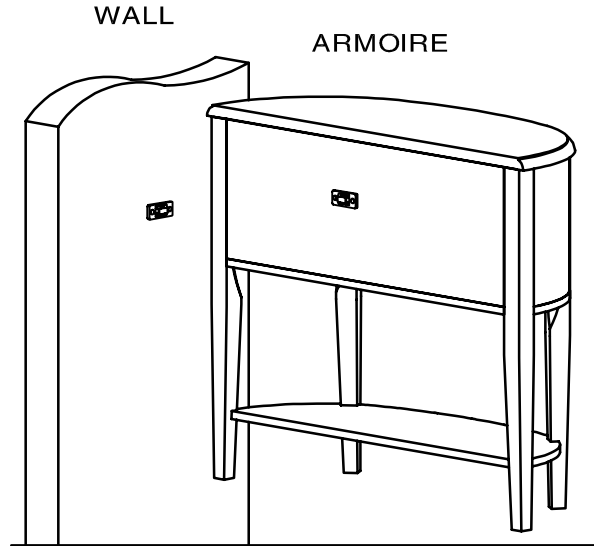
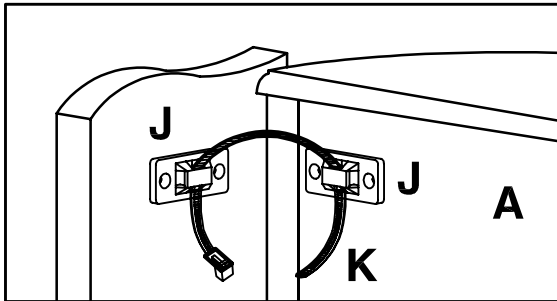

IF YOU HAVE A PROBLEM, WE WANT TO HAVE THE OPPORTUNITY TO MAKE IT RIGHT !

Should there be any missing or defective part(s),

Fax this form to (310) 841-0842

or call Customer Service at (800) 622 4456 or (310) 204-2224
Have your model number and part code letter handy.

MODEL NO. 502-515

© 2007 POWELL

Part letter	Description	Quantity

Name _____
 Address _____

 Daytime Phone () _____
 Reason for replacement _____

 Place of purchase _____