

# READ THESE INSTRUCTIONS CAREFULLY BEFORE ATTEMPTING TO ASSEMBLE THIS BED.

## SAFETY WARNINGS AND GENERAL NOTES:

- Follow the information on the warnings appearing on the upper bunk end structure and on the carton. Do not remove warning label from bed.
- Always use the recommended size mattresses or mattress supports, or both, to help prevent the likelihood of entrapment or falls. (See Page 9)
- The top surface of the mattress must be at least 5" below the upper edge of the guardrails. (See Page 9)
- Do Not allow children under 6 years of age to use the upper bunk.
- Prohibit more than one person on the upper bunk.
- Periodically check and ensure that the guardrail, ladder and other components are in their proper position, free from damage, and that all connectors are tight.
- Do not allow horseplay on or under the bed. Always prohibit jumping on the bed.
- Always use the ladder for entering and leaving the upper bunk.
- Do not use substitute parts. Contact the manufacturer or dealer for replacement parts.
- Use of a night-light may provide added safety precaution for a child using the upper bunk.
- If the bunk bed will be placed next to a wall, the guardrail that runs the full length of the bed could be placed against the wall to prevent entrapment between the bed and the wall.
- Always use guardrails on both long sides of the upper bunk.
- The use of water or sleep flotation mattresses is prohibited.
- Keep these instructions for future reference.
- We recommend assembling your bunk bed on the shipping carton to protect your floor or carpet. Be certain all staples are out of the box before beginning assembly on the shipping carton.

Replacement parts, including additional guardrails, may be obtained from any of our AMERICAN WOODCRAFTERS dealers.

### Identifying the Parts...

Use the illustrations below to correctly identify each of the parts of your bed.

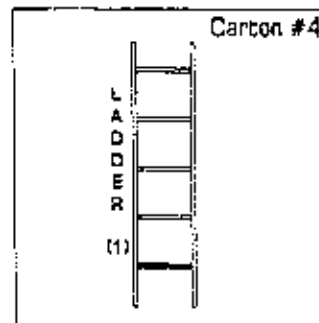
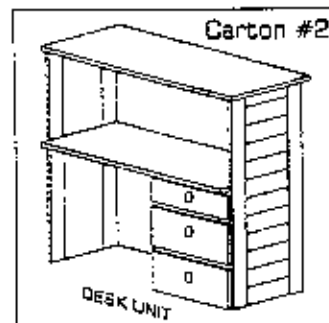
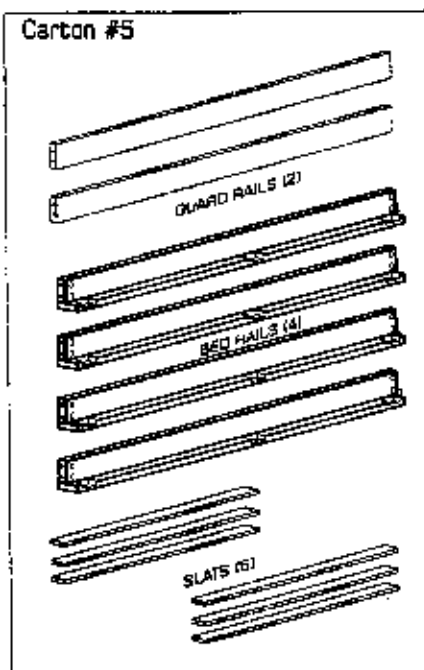
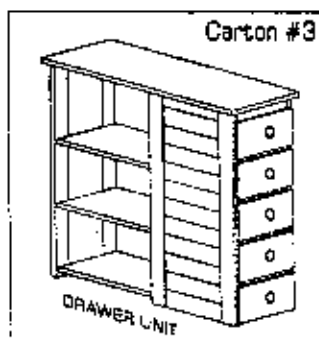
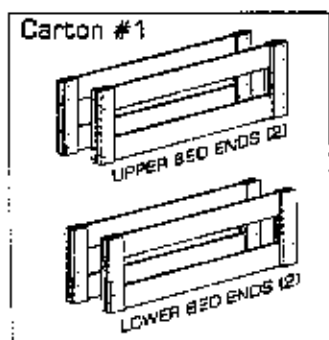

## Identifying the Hardware...

Identify the hardware using the illustrations below.

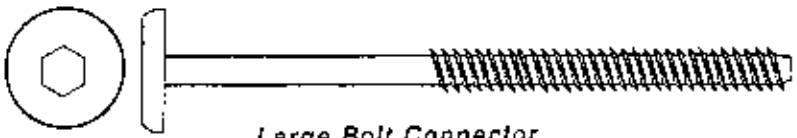
ID # <b>A</b>		Quantity <b>24</b>
Large Bolt Connector		

ID # <b>B</b>		Quantity <b>24</b>
C-Nuts (Half Moon)		

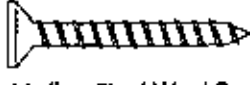
ID # <b>C</b>		Quantity <b>12</b>
Medium Sized Wood Screw		

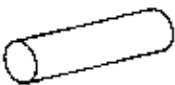
ID # <b>D</b>		Quantity <b>4</b>
Metal Dowel		

ID # <b>E</b>		Quantity <b>2</b>
Small Wood Screw		

ID # <b>F</b>		Quantity <b>4</b>
Caster Sleeve		

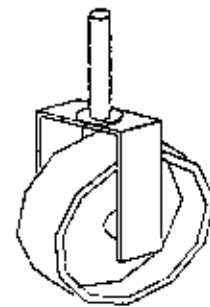

ID # <b>G</b>	Caster	Quantity <b>4</b>
------------------	--------	----------------------

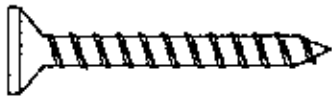
ID # <b>H</b>		Quantity <b>4</b>
Large Sized Wood Screw		

## Tools Required...



4mm Hex Key

Step  
1

- Place the DESK UNIT and the DRAWER UNIT as shown in a straight line in their intended location. (It will be very difficult to move the assembly once complete) Use a tape measure and place the pieces 80" apart, outside edge to outside edge as illustrated below.
- Make sure the assemblies are turned as shown.

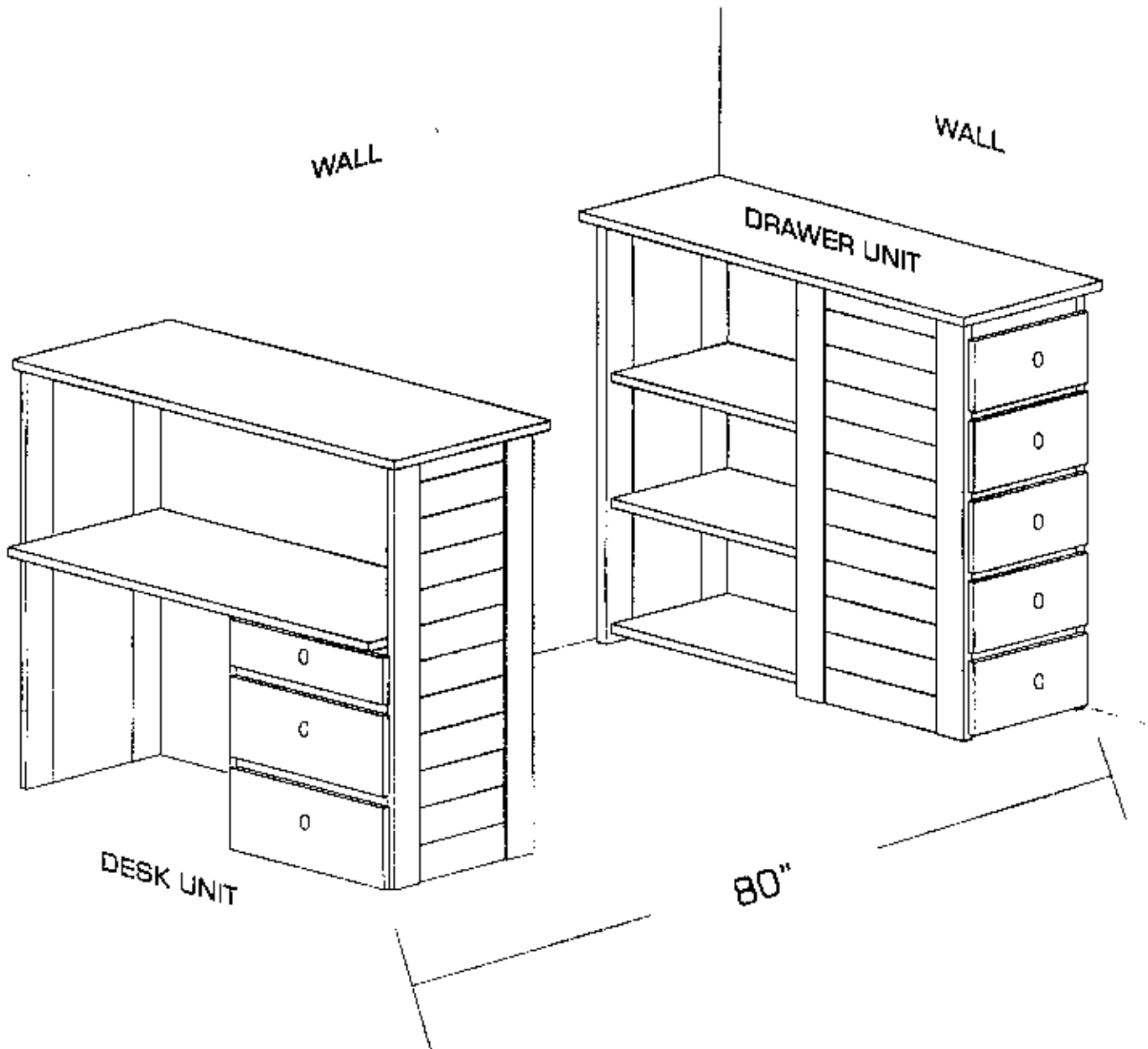

# Step 2

- Select the UPPER & LOWER BED ENDS, the BED RAILS and the GUARD RAILS.
- Place C-NUTS (B) onto each of the LARGE BOLT CONNECTORS (A).
- Attach the BED RAILS and the GUARD RAILS to the UPPER BED ENDS and the BED RAILS to the LOWER BED ENDS by threading the LARGE BOLT CONNECTORS (A) through the holes in the BED ENDS and into the pre-drilled holes in the ends of the BED RAILS and GUARD RAILS. Use the hex key to tighten the LARGE BOLT CONNECTORS (A).
- Insert the CASTER SLEEVES (F) into the LOWER BED ENDS as shown. Then insert the CASTERS (G) into the CASTER SLEEVES (F) as illustrated.

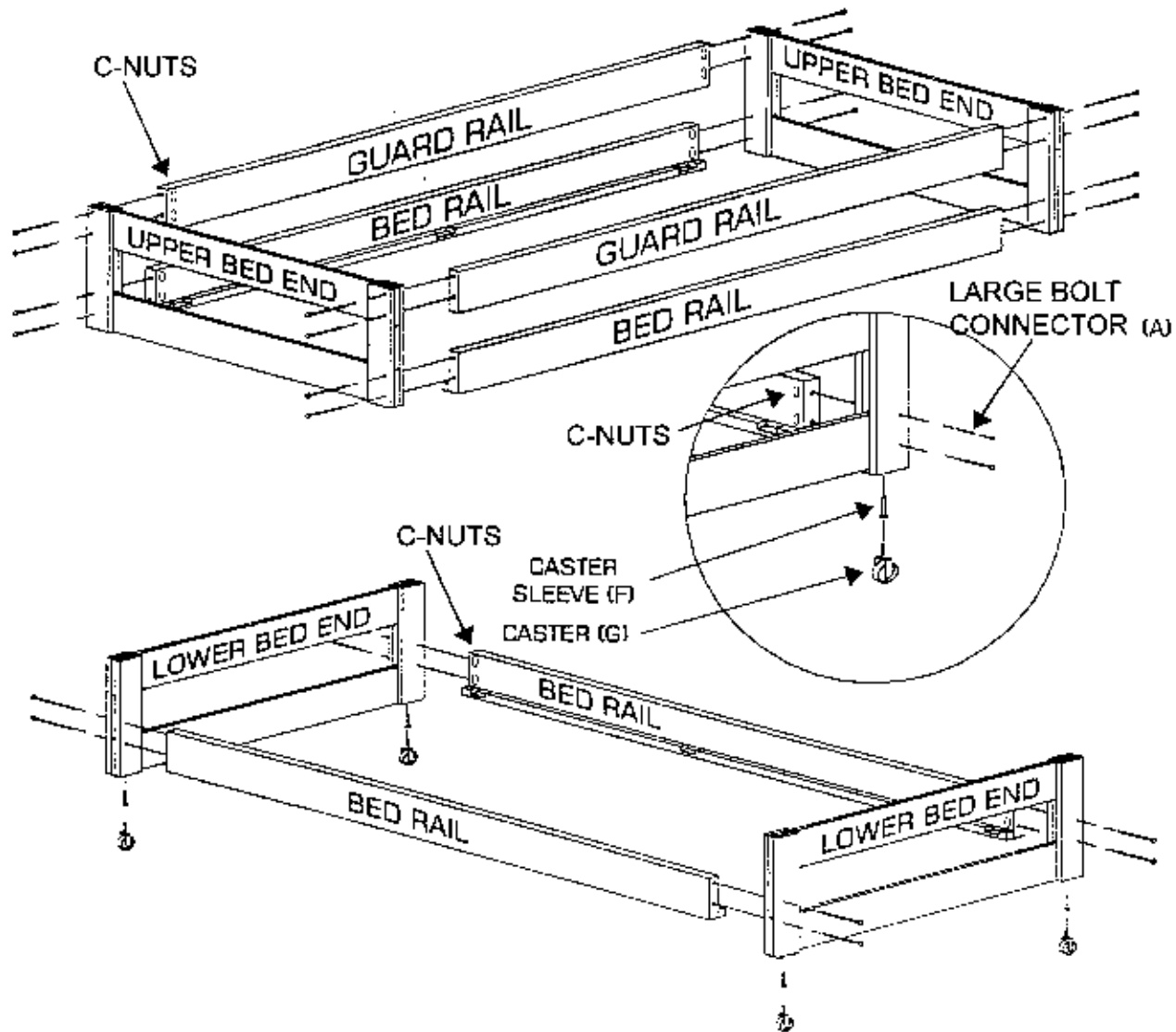

## Hardware Used In This Step...

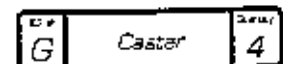
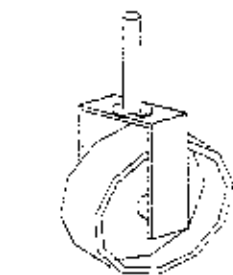
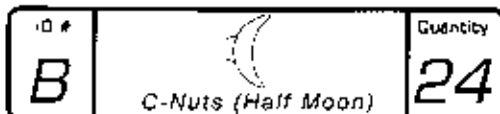
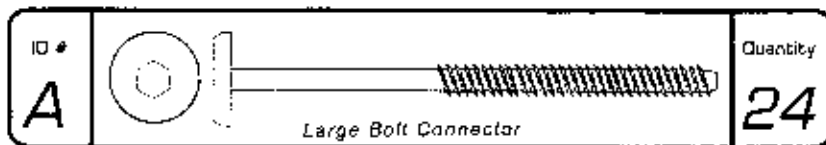

Step

3

- Select the SLATS and insert them into the UPPER & LOWER BED ASSEMBLIES as shown. Please note that the two SLATS closest to the BED ENDS should rest tightly into the notched area as illustrated. The other SLAT should be placed in the middle of each bed.
- Secure the SLATS to the BED RAILS using the MEDIUM WOOD SCREWS (C).
- NOTE: Slats must be placed in notched areas and screwed down tightly

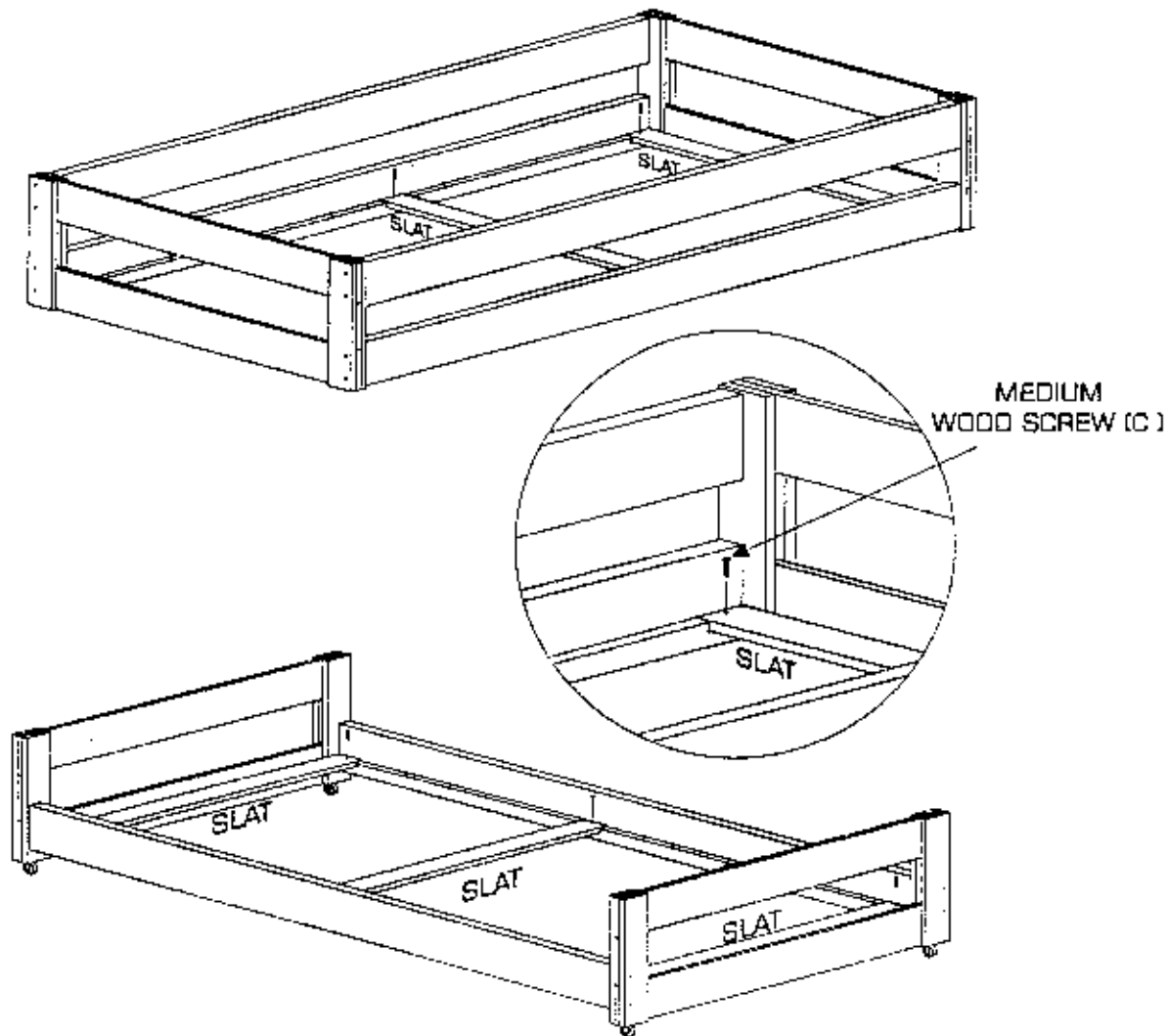

### Hardware Used In This Step...

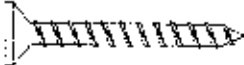
ID #		Quantity
C	 Medium Sized Wood Screw	12

Step

4

- Select the UPPER BED ASSEMBLY and the LOWER BED ASSEMBLY. Place the LOWER BED ASSEMBLY in the space between the DESK ASSEMBLY and the DRAWER ASSEMBLY.
- Place the METAL DOWELS (D) into the holes shown in the top of the DESK ASSEMBLY and the DRAWER ASSEMBLY as shown.
- With the help of a friend, place the UPPER BED ASSEMBLY onto the DESK & DRAWER ASSEMBLIES making sure the METAL DOWELS enter the holes in the bottom of the UPPER BED ENDS.
- In order to make the Upper Bed more sturdy, two (2) holes have been bored in each of the Bed Rail cleats, approximately 14-3/4" in from the end of each rail. Once the Upper Bed Assembly has been assembled and has been placed onto the Desk and Drawer units, and the three (3) slats have been screwed in place, insert one (1) each of the large wood screw (H) into each of the holes and screw the rails into the top of the Desk and Drawer unit, securing the Upper Bed Assembly to the Desk and Drawer units.

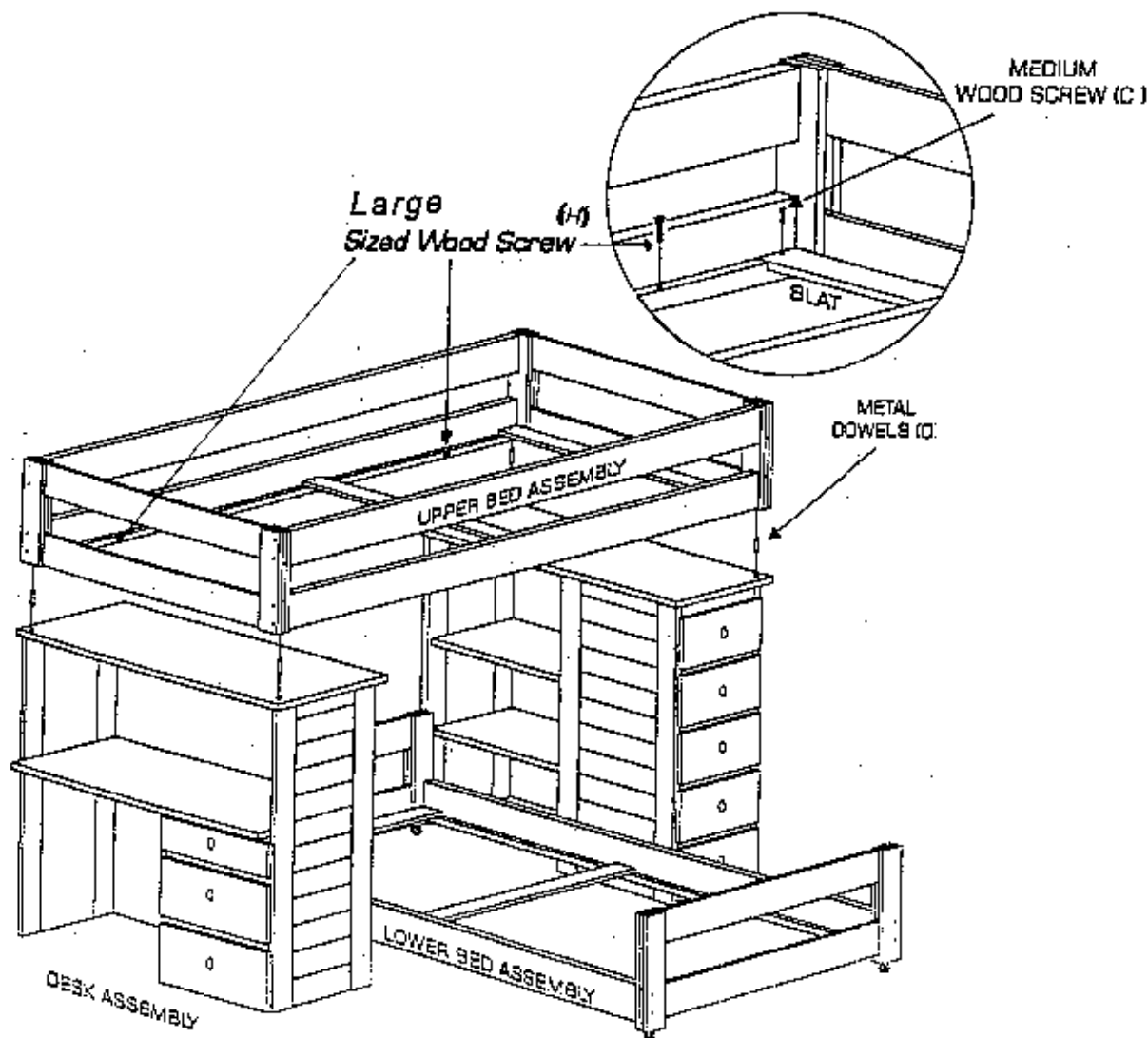

### Hardware Used In This Step...

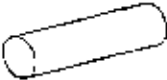
ID #		Quantity
D	 Metal Dowel	4

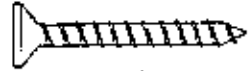
ID #		Quantity
H	 Large Sized Wood Screw	4

Step

5

- Place the LADDER in the location shown by making sure the metal hooks on the top of the LADDER are hooked over the top edge of the GUARD RAIL.
- Secure the LADDER in place by threading two SMALL WOOD SCREWS (E) through each ladder hook and into the GUARD RAIL.
- Your assembly is now complete. Clean and polish as needed and enjoy your new bed!

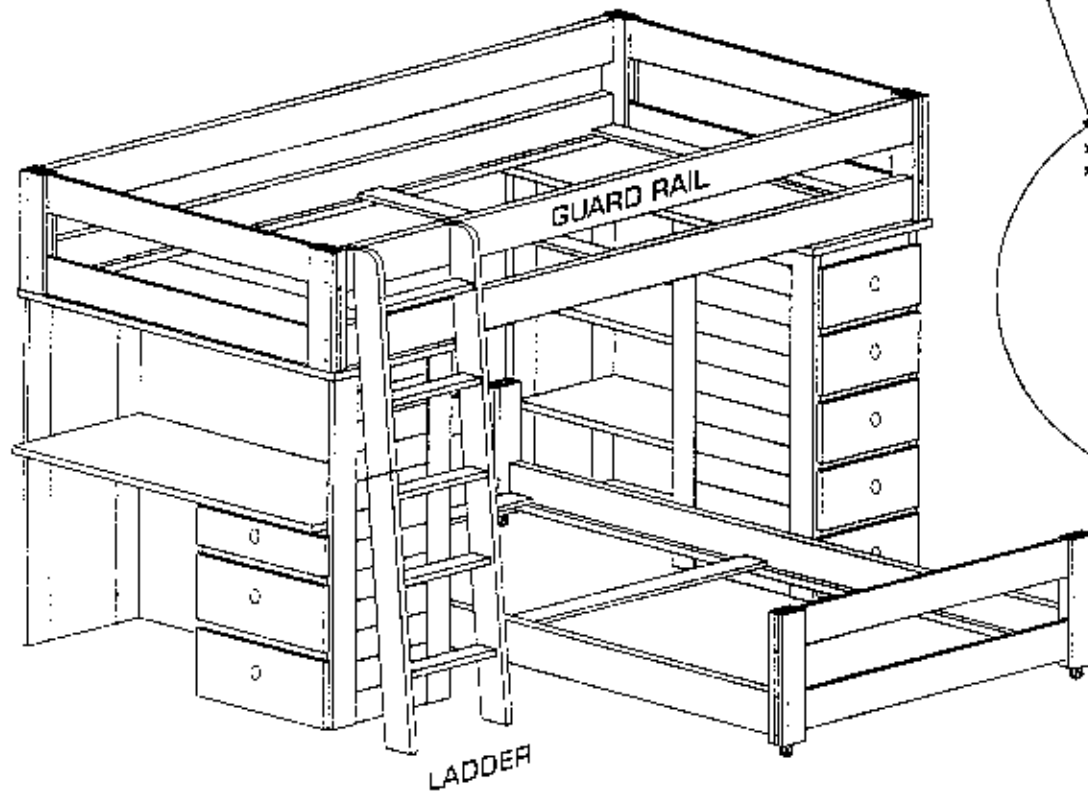

### Hardware Used In This Step...

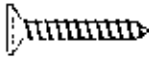
ID #		Quantity
E	 Small Wood Screw	2