

**1A** Parts in this Box:

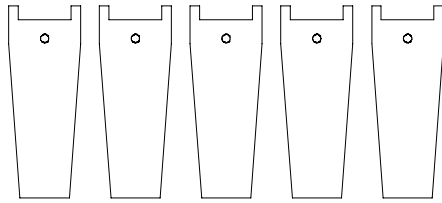

Small Legs **x 5**



Wooden Feet **x 5**

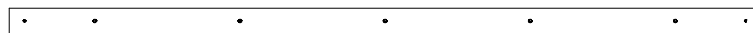

Center Rail **x 1**

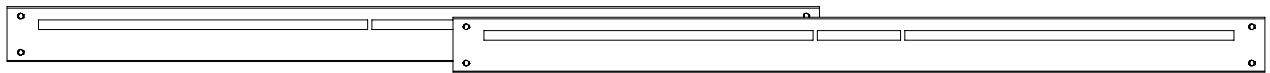

Stretchers **x 2**

**1B** Slats are Packed Separately in Box 4.

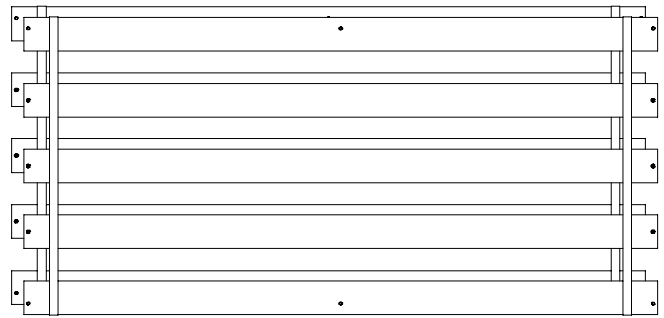

Set of Slats **x 2**

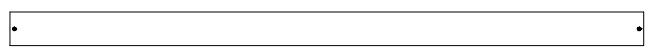

Single Slat **x 1**

**1C** Hardware in this box.

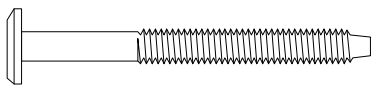

60mm Bolts **x 5**

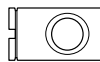

Barrel Nuts **x 5**

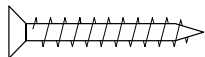

30mm Wood Screws **x 12**

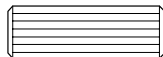

Wooden Dowels **x 8**



ThumNut™ **x 8**  
Patent No.: US 6,457,923

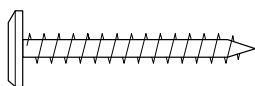

40mm Threaded Wood Bolts **x 12**

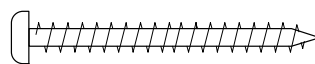

50mm Round Head Wood Screws **x 10**



Long Allen Key **x 1**

**1D** Fit Wood Dowels to the Stretchers:

Tap the Wooden Dowels all the way into the Middle holes at the ends of the Stretchers.

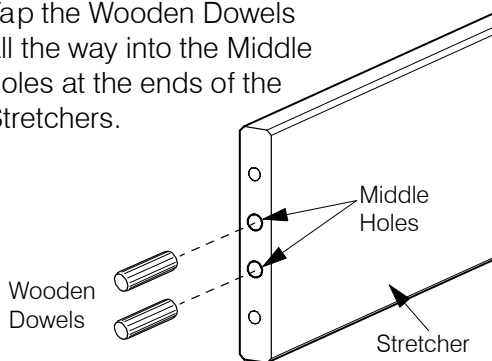

**1E** Fit the Small Legs to the Center Rail.

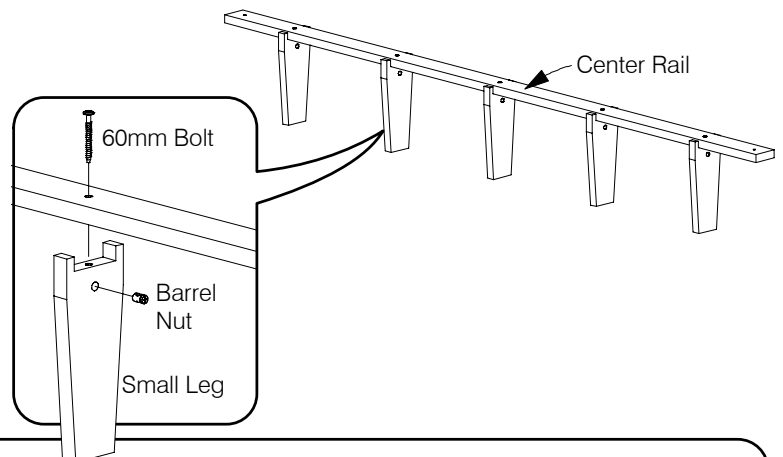

**2A Attach the Stretchers to the Headboard and Footboard.**

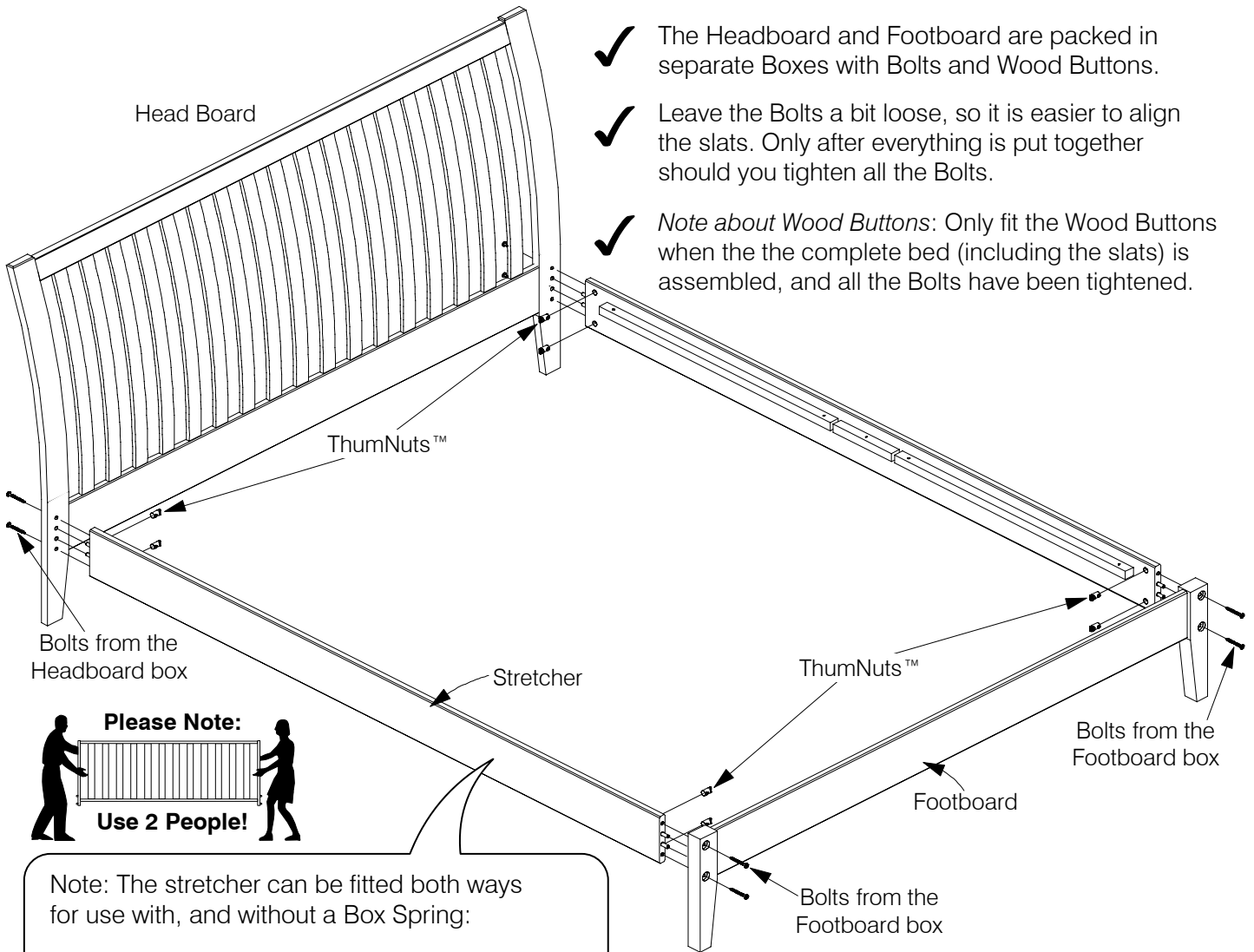

- ✓ The Headboard and Footboard are packed in separate Boxes with Bolts and Wood Buttons.
- ✓ Leave the Bolts a bit loose, so it is easier to align the slats. Only after everything is put together should you tighten all the Bolts.
- ✓ *Note about Wood Buttons:* Only fit the Wood Buttons when the the complete bed (including the slats) is assembled, and all the Bolts have been tightened.

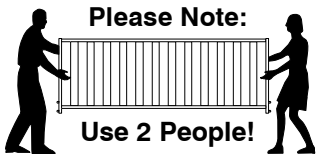

Note: The stretcher can be fitted both ways for use with, and without a Box Spring:

**With a Box Spring:**

Fit the stretcher this way...

...and use the small legs without the wooden feet.

**With Mattress only:**

Fit the stretcher this way...

...and fit the wooden feet to the small legs. (Step 2B)

**2B For Mattress Only: Fit the Wooden Feet to the Small Legs.**

Philips screwdriver (not included)

50mm Round Head Wood Screws

Wooden Feet

Small Legs

Center Rail

**3A Fit one Set of Slats between the Stretchers.**

Lay one Set of Slats out loosely inside the Stretchers as shown below.

Use two of the 40mm Threaded Wood Bolts to fix the end slat in place.

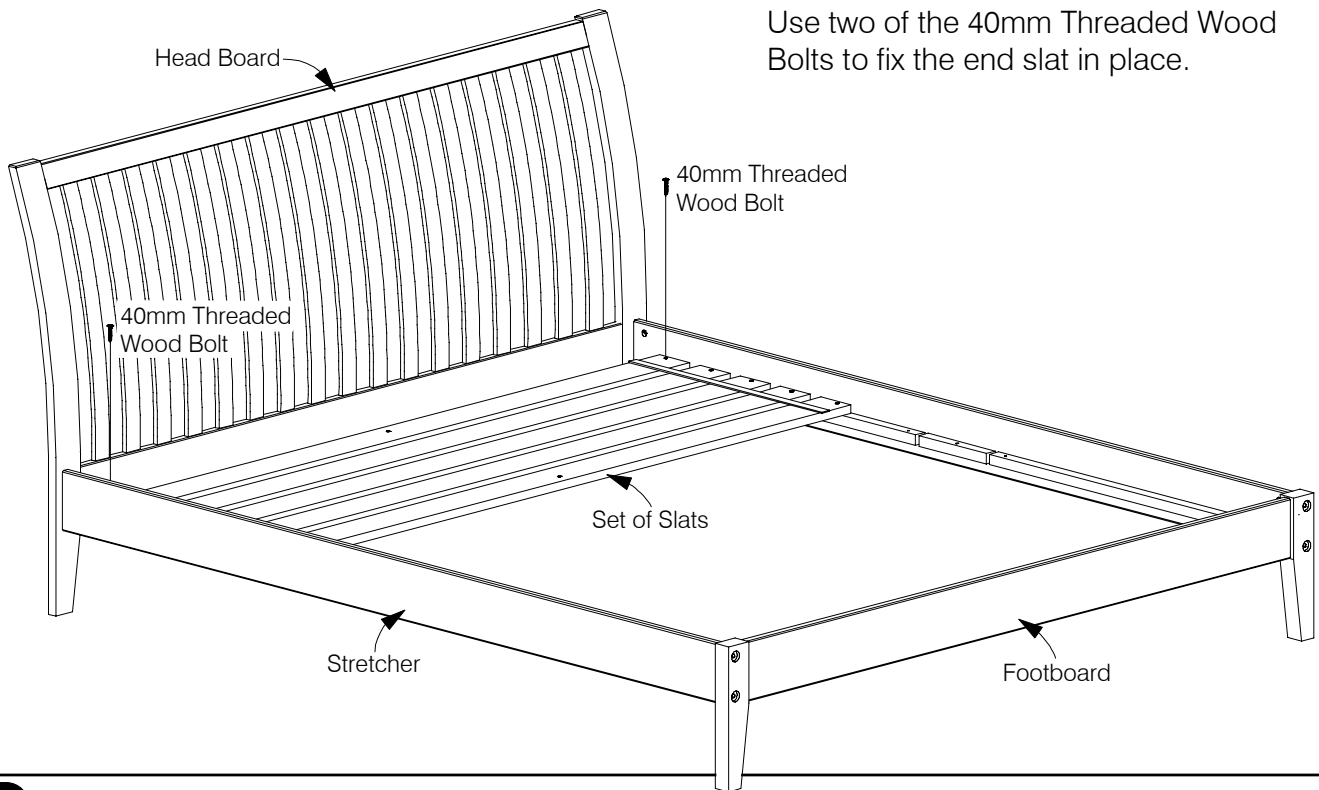
**3B Fit the Center Rail.**

Position the Center Rail with the Small Legs beneath the Slats. Line up the hole in the Center Rail with the center hole in the Slat. Bolt it in place with a 40mm Threaded Wood Bolt.

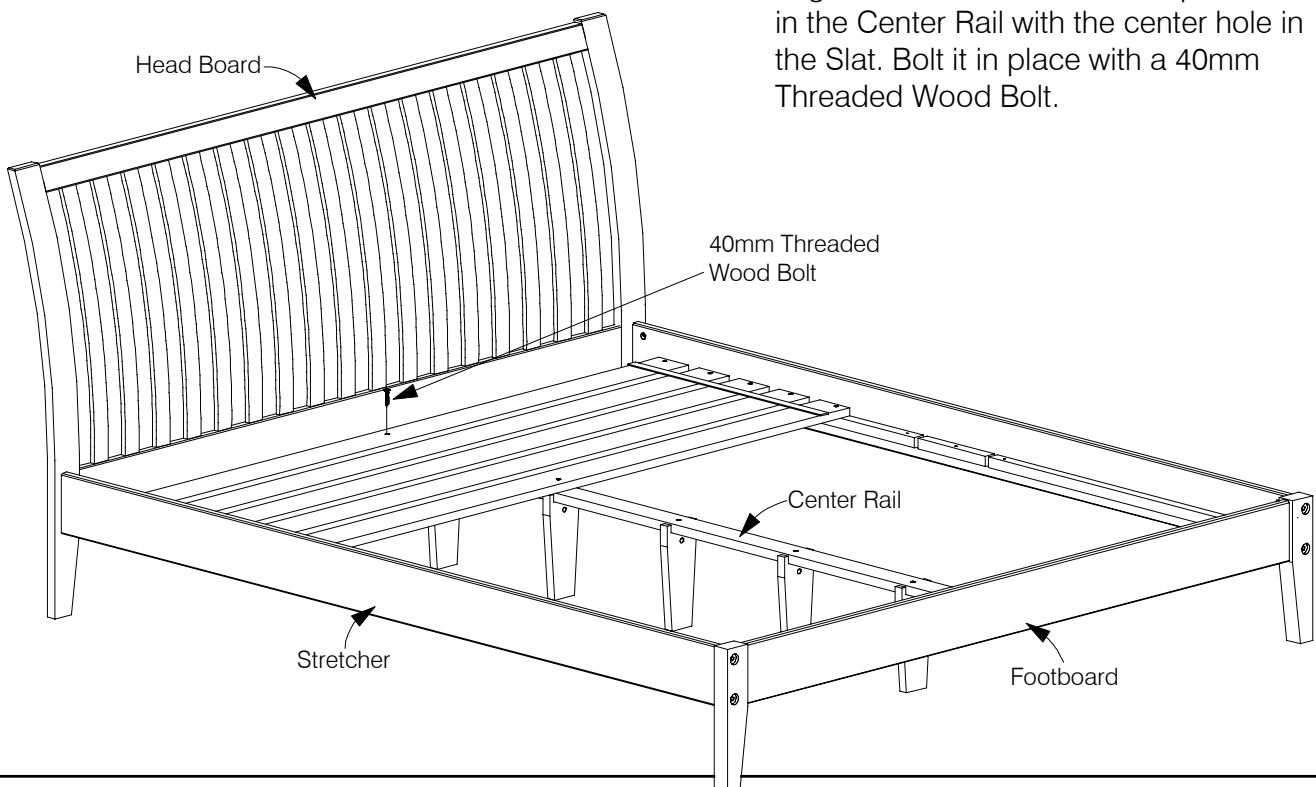

**4A Fit the other Set of Slats between the Stretchers.**

Lay the other Set of slats out loosely inside the Stretchers at the Footboard end. Fix with 40mm Threaded Wood Bolts.

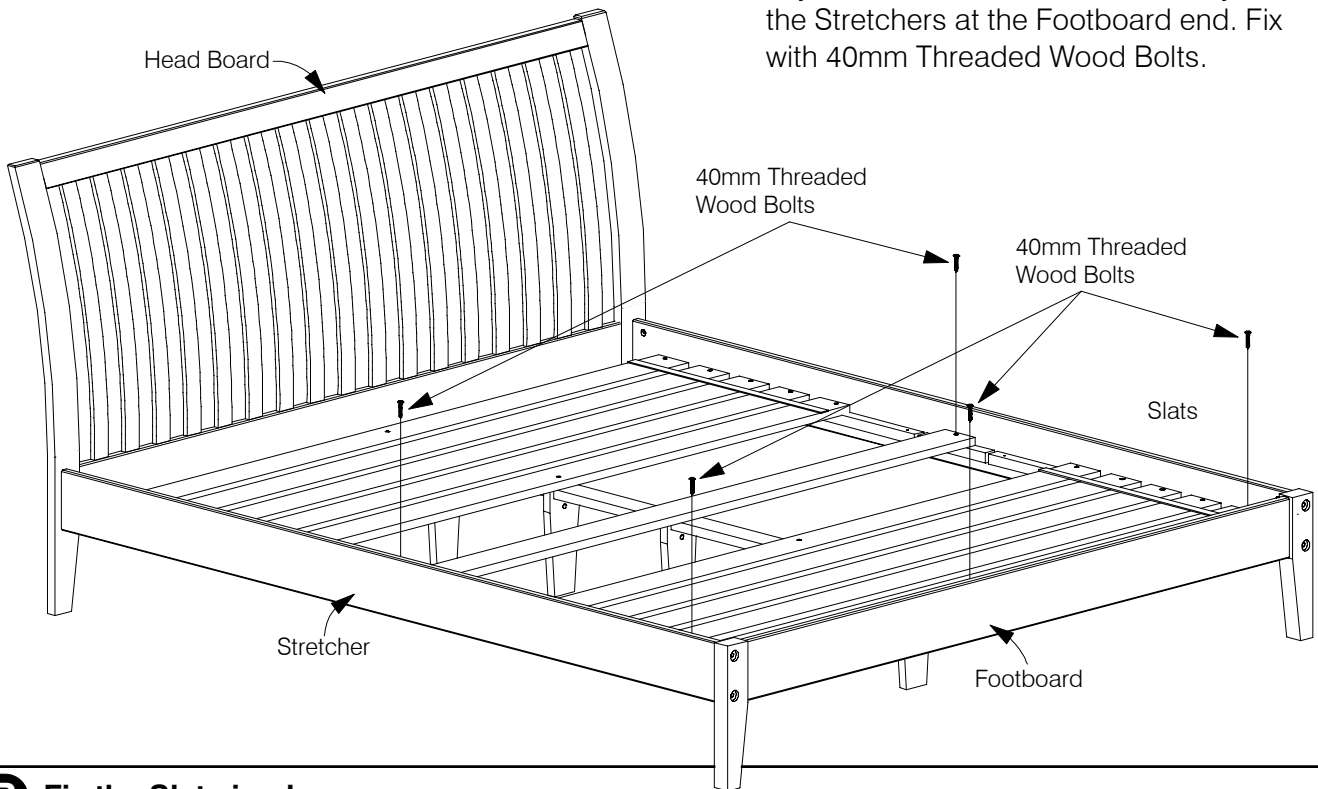

**4B Fix the Slats in place.**

Open out the Slats and fix with 40mm Threaded Wood Bolts.

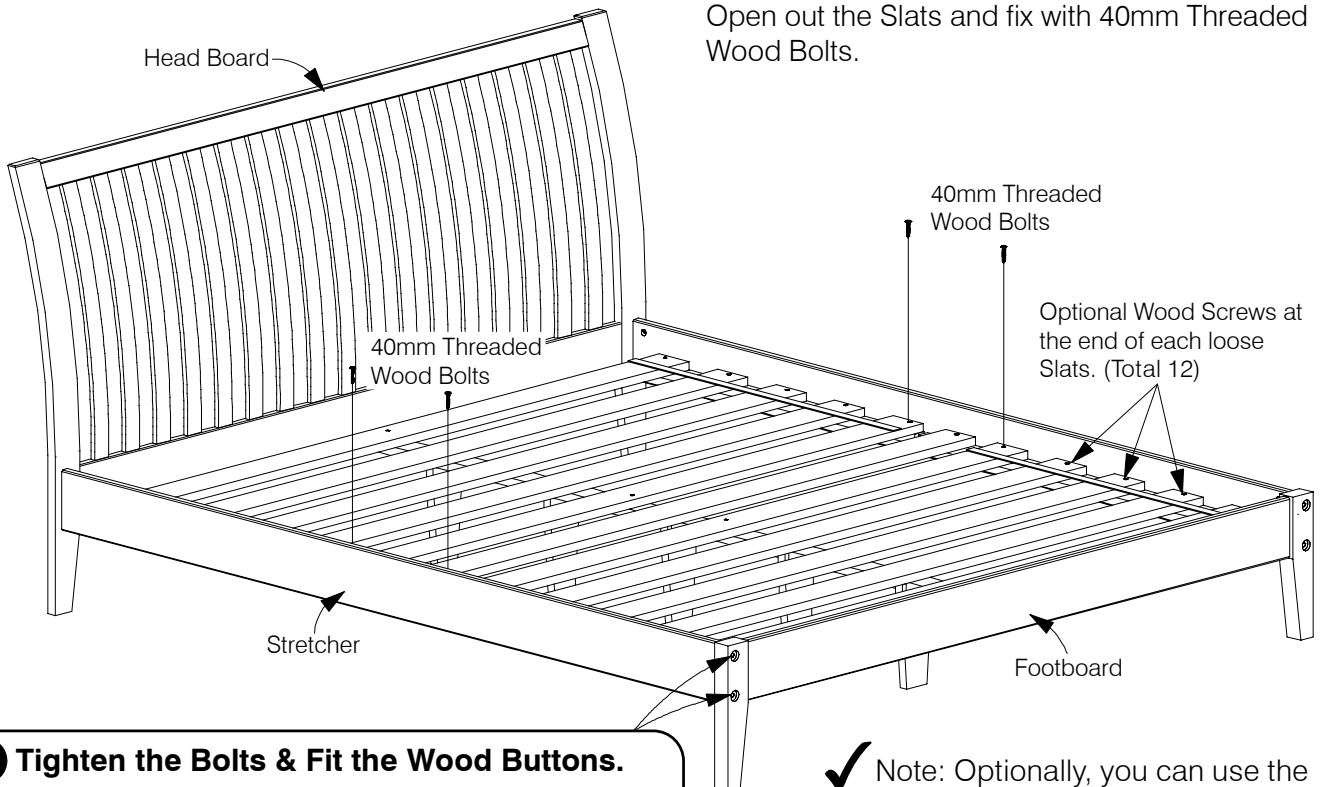

**4C Tighten the Bolts & Fit the Wood Buttons.**

Only when everything is put together and the Bolts have been tightened, push fit the Wood Buttons into the Bolt holes.

✓ Note: Optionally, you can use the enclosed Wood Screws to fix each slat in place. An electric screwdriver will make this much easier.