



CANOPY
FACTORY™

Model #23522

10' x 20'

All-Purpose Canopy

Installation Instructions

Please read instructions
COMPLETELY before assembly.



**DO NOT RETURN
PRODUCT TO
THE STORE**

**Missing Parts,
Need Replacements, or
Help with Assembly**

**Please Contact
Customer Service:
1-800-524-9970**

North American
Outdoor Products
13 Wood Street • West Haven
CT 06516







www.outdoorfactory.com

Pg.1

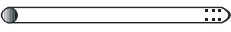
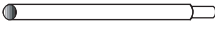
01-23522

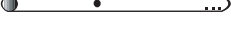
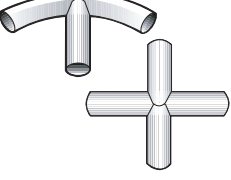
2/7/04

01-97561

	Description	Qty.	Part #
	24.4" Rafter Tube	8	13104
	40.7" Swedged Tube	25	13103
	39.5" Straight Cross Tube	9	13107
	39" Straight Tube with extra hole for top of leg	8	13105
	3-Way Frame Connectors	6	13101
	4-Way Frame Connectors	6	13102
	White Valance Cover	1	10072
	White Bungee Cords	24	10066
	Base Feet	8	10075

Patent NO. ZL 02 2 160 11.6 and other patents pending.

WARNING!

Use **CAUTION** when assembling this unit. Manufacturer recommends the use of safety goggles during assembly. Bungees are under extreme tension and may snap out of your hand and cause injury. Be aware of poles over your head during assembly that may not be secured, and could fall and cause injury.

Diagram A

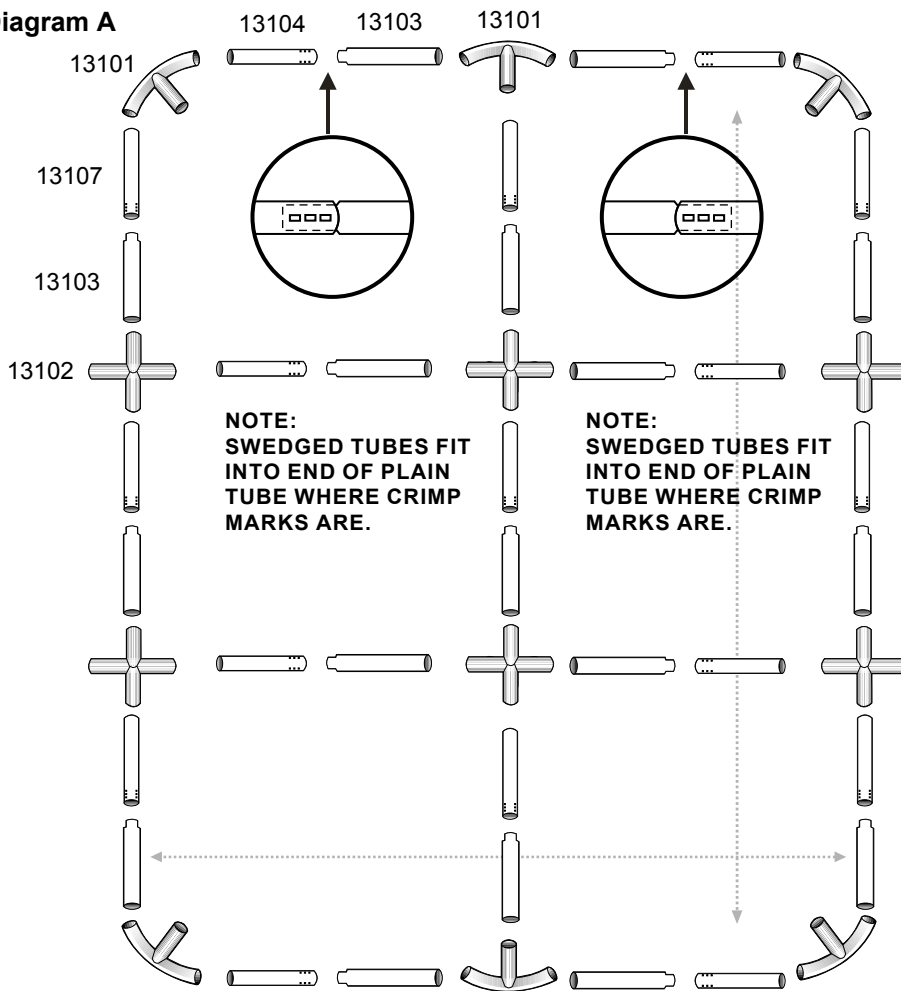

Diagram C

Diagram B

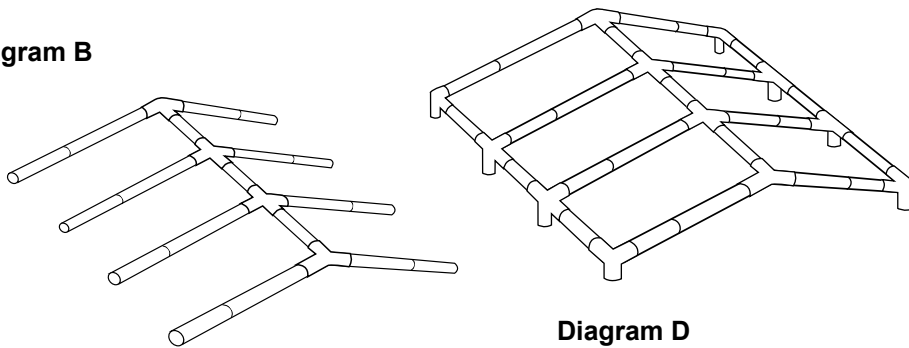

Diagram D

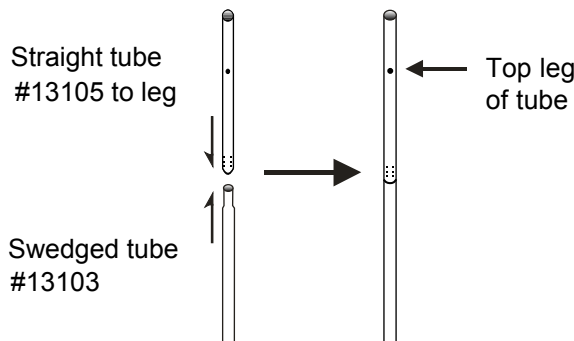
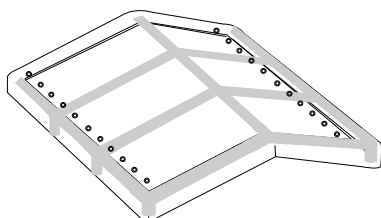

Diagram E



Step 1

EASY FRAME LAYOUT

First, layout all the frame parts exactly as shown in diagram 1.

Note: SWEDGED TUBES FIT INTO THE END OF THE PLAIN TUBE WHERE THE CRIMP MARKS ARE.

(See Diagram A)

Step 2

FRAME ASSEMBLY

Next, combine all the parts listed below to form the frame, starting with the center peak, and then assemble each side.

- 17 - #13103 (40.7" Swedged Tubes)
- 8 - #13104 (24.4" Rafter Tubes)
- 9 - #13107 (39.5" Straight Cross)
- 6 - #13101 (3-Way Frame Connector)
- 6 - #13102 (4-Way Frame Connector)

(See Diagrams B & C)

Step 3

POLE ASSEMBLY

Connect one each of part # 13105 and # 13103 then set them aside for now.

- 8 - #13105 (39" Straight Tubes with extra hole for top of leg)
- 8 - #13103 (40.7" Swedged Tubes for bottom of leg)

(See Diagram D)

Step 4

Place cover over frame with the grommets facing downward allowing the valance to wrap around and cover the eaves of the frame.

(See Diagram E)

Diagram F

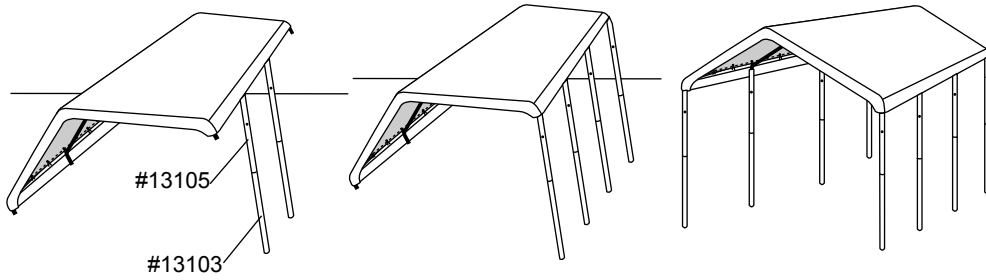
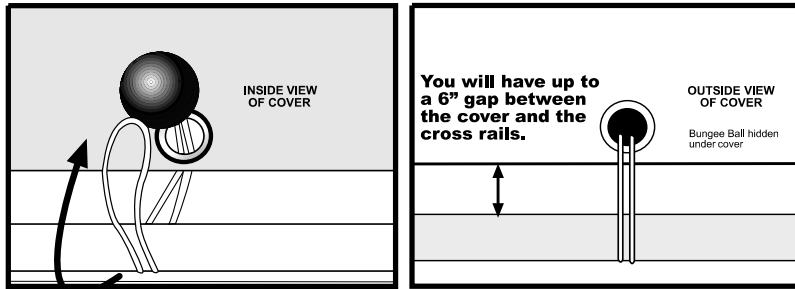

Diagram G



Working from the inside of the cover, you can hide the bungee balls from the outside, giving the canopy a cleaner look.

Diagram H
COVER

Cover S-Hooks are designed to hold the front & back of the cover tightly in place.

1. Hook one onto each of the INSIDE of the cover legs.
2. Adjust the drawstring evenly on each side of the canopy by pulling the drawstrings on each end of the cover at the same time
3. Secure rope to "S" Hook
4. The next step will feature our new "TwistTight" procedure to fit the cover snugly.

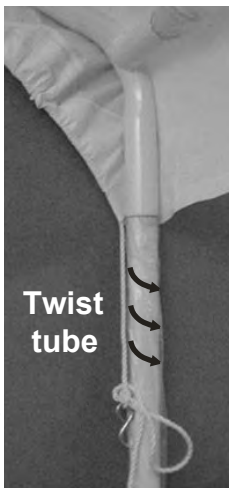
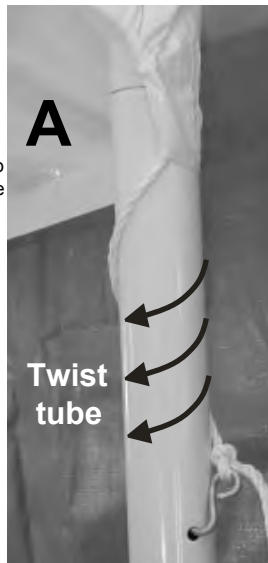

Diagram I
TwistTight™

1. To get your cover to fit snugly over the frame, "twist" each corner leg pole equally until the cover becomes very tight. (diagram A). Make sure to line up the hole in the top of the leg with the hole in the corner side bends.



Twist tube this direction to tighten cover

Diagram J

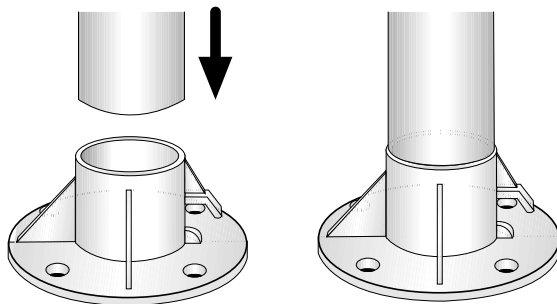

Step 5 ATTACHING LEGS

For this step you will use the 8 leg poles you put together in step 1.

First you will use part #13105 with the pre-drilled hole at the top, insert the center leg on one side, and then do the same for the corner legs. Repeat this procedure for the other side.

Now you can secure the legs to the side bend connectors with push buttons. Insert the leg extensions onto the bottom of the legs.

(See Diagram F)

Step 6 SECURING COVER

Insert the cord of the bungee-ball through the grommet, around the eaves, and then the ball. When all 4 corners are secured, work from side to side to get an even fit. If bungee cords are too loose, you can double wrap them around the eaves.

(See Diagram G, H, & I)

WARNING!
USE CAUTION WHEN ATTACHING BUNGEE CORDS, THEY CAN SNAP OUT OF YOUR GRIP AND MAY CAUSE INJURY.

Step 7 BASE FEET

Insert the Base Feet Plates onto the bottom of the legs.

(See Diagram J)

Manufacturer's Suggestion:
When you take your unit down for the season, we recommend leaving the poles assembled so that the next time you put up the unit it will be easier to construct.

DO NOT expose the canopy to open fire or flame by using BBQ grills or smoking under the canopy. **DO NOT** use harsh abrasives, bleach or cleansers.

Cover can be easily cleaned with mild soap and water.

North American Outdoor Products **DOES NOT** guarantee and will not be held responsible for any canopy exposed to and / or damaged by conditions of snow, ice, heavy rain, or high wind under **ANY** circumstance. We also will not be responsible for any other damage caused by the canopy or to the canopy. Therefore, you will need to remove the cover when you know that a strong or severe weather front is approaching. We suggest you contact your insurance carrier for information just as you would for any other outside structure.

Our canopies are designed to offer protection from damage caused by the sun, light rain, tree sap, and birds.

THIS IS A TEMPORARY STRUCTURE AND IS NOT RECOMMENDED AS A PERMANENT STRUCTURE.

After assembly your structure must be anchored to prevent damage. **PROPER ANCHORING IS YOUR RESPONSIBILITY** . Periodically check the stakes or anchors to ensure stability of the unit, especially following exposure to the elements such as high winds or heavy rain. The preferred anchoring system uses screw-in anchors and cable attached to each leg. Mobile home anchors will also work. Any canopy that is not anchored properly or securely will fly away and we will not be held responsible for a canopy that has blown away.

Replacement parts are available. We offer several anchoring kits, walls, tubes, as well as additional covers, and other accessories. Any item purchased is shipped factory direct, thus ensuring consistent quality of our products.

For more information, please contact our customer service department **Mon-Sat. 8:30 AM - 5PM EST.**

CARE AND CLEANING INFORMATION

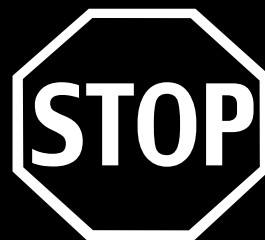

**IMPORTANT!!
OUR GUARANTEE
PLEASE READ
CAREFULLY**

PROPER AND IMPROPER ANCHORING OF CANOPY

EFFECTS OF STRONG WINDS, SNOW OR ICE

**Missing Parts,
Need Replacements, or
Help with Assembly**

**Please Contact
Customer Service:
1-800-524-9970**

North American
Outdoor Products
13 Wood Street • West Haven
CT 06516
www.outdoorfactory.com