

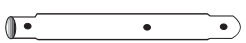

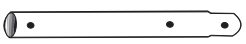

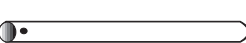

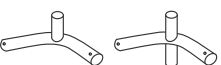

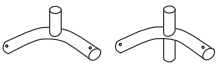
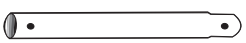

18 X 20 Model #26773 PREMIUM INDUSTRIAL CANOPY

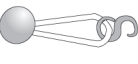
Please read instructions completely before assembly

	Description	Qty.	Part #
	67" Swedged Rafter Poles	8	10042
	76" Swedged Leg Poles	8	10043
	77.4" Cross Poles	9	10044
	(Top Bend, shallow bend) 3-Way Frame Connectors	2	10046
	4-Way Frame Connectors	2	10048
	(Side Bend, sharp bend) 3-Way Frame Connectors	4	10045
	4-Way Frame Connectors	4	10047
	42.5" Swedged Rafter Poles	8	10142
	All-Weather Cover	1	10159
	Bolts 1/4" x 2 1/2"	16	10017
	Nuts 1/4"	8	1010
	Wing Nuts	8	7000
	Twist Tight™ Set (bungee & S hook)	4	10056
	Bungee Cords	24	10066
	Cable 82" Length	4	12117
	Long Pins w/rings 3"	8	10052
	Short Pins w/rings 2.4"	8	10051
	Foot Plates	8	10050

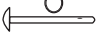

**DO NOT
RETURN
PRODUCT TO
STORE**

**FOR MISSING OR
REPLACEMENT
PARTS
PLEASE CONTACT
CUSTOMER
SERVICE:
1.800.524.9970**



17 Wood Street
West Haven, CT 06516
1.800.524.9970

ATTENTION: PINS

8 -3" Pins secure feet plates to legs.
8 -2.4" Pins secure legs to side bends.

Pins are for legs and feet only, and are NOT needed for any other part of the frame.

1. FRAME ASSEMBLY

Assembly is easiest if you layout all parts as shown. There are (8) #10042 Rafter Poles, they are swaged on both ends. (8) #10142 Rafter Poles, they are swaged end. The (9) #10044 Cross Poles do not have swaged ends. It is very important that you determine which of the 3 & 4 way connectors are meant for the sides and which are for the crest.

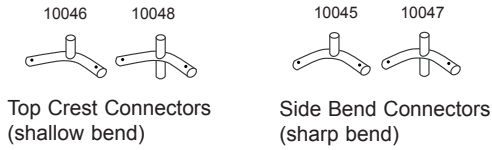
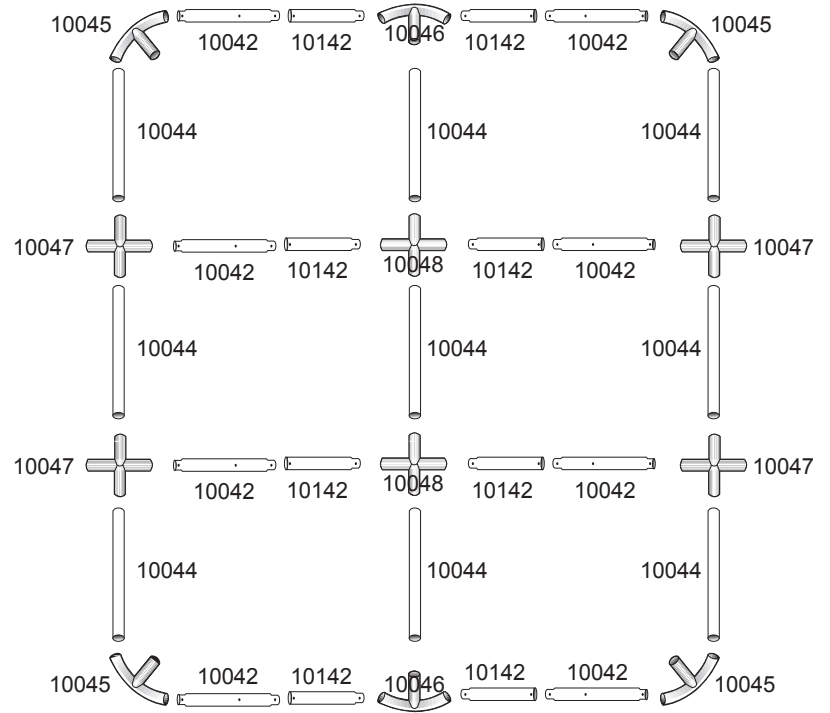

2. Assemble Roof

Start with center, Fig. 1, using layout shown in diagram above. Bolt roof assembly together as shown in Fig. 1A. Assemble each side of the roof as shown in Fig. 2. Install #12117 truss brace roof cables as shown in Fig. 2A.

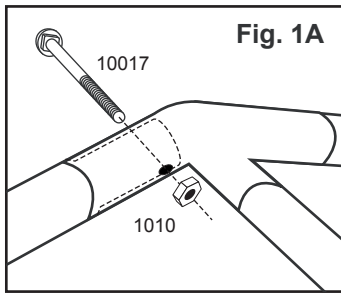

Note: Install all carriage bolts with nut toward center of frame.

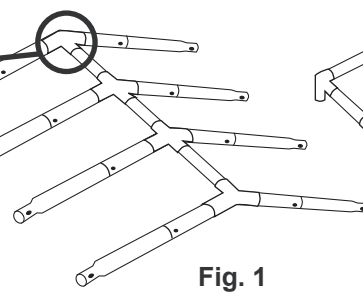

Fig. 1

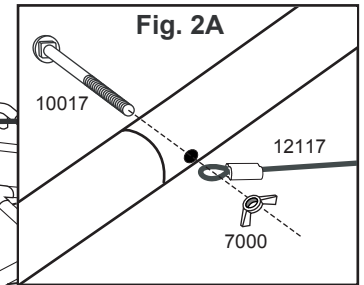

Fig. 2

3. PLACE COVER

Place cover over frame so that the grommeted portion is face down, this allows the valance to wrap around and cover the frame eaves.

4. ATTACHING LEGS

Insert #10043 Leg Poles on one side of the frame, swaged end up, then the end legs on that same side. Repeat for the other side. Now you can secure the legs to the side bend connectors and secure the cover with bungee cords.

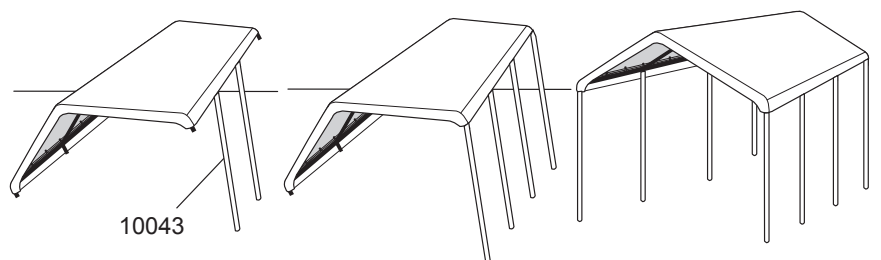
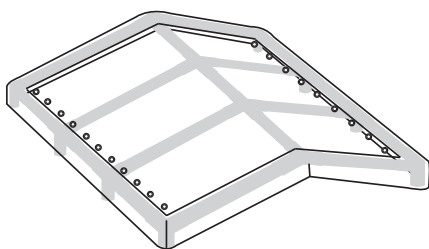

5. SECURING LEGS

8 Short Pins are used to secure legs to side bend connectors.

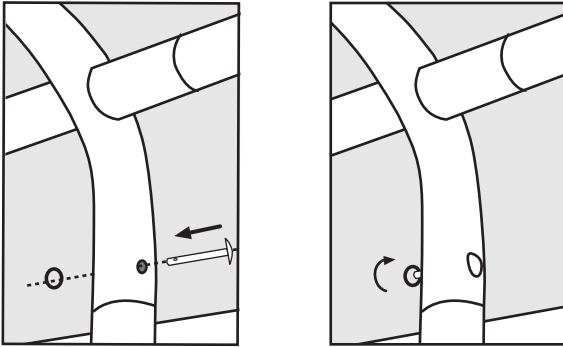

6. SECURING COVER

Working inside, under-neath the unit, begin with the corners. Insert the cord of the bungee-ball through the grommet and around the #10044 Cross Pole, then around the ball. By doing this from the inside it will hide the bungee-ball and give a cleaner look. When all 4 corners are secured, work from side to side to get an even fit.

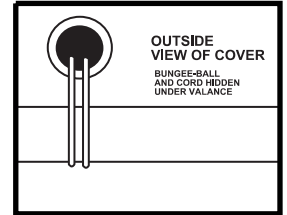
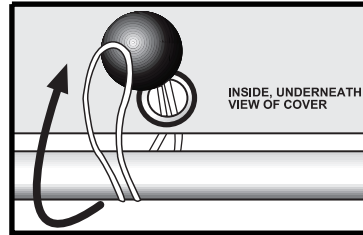

7. TwistTight

7.1 To get your cover to fit snugly over the frame, "twist" each corner leg pole equally until the cover becomes very tight. (picture A). Make sure to line up the hole in the top of the leg with the hole in the corner side bends.

7.2 Picture B To keep the leg in place, wrap the bungee cord around the cross rail, insert "S" hook into lined up hole of leg pole and 3 way connector. Do this for each corner.

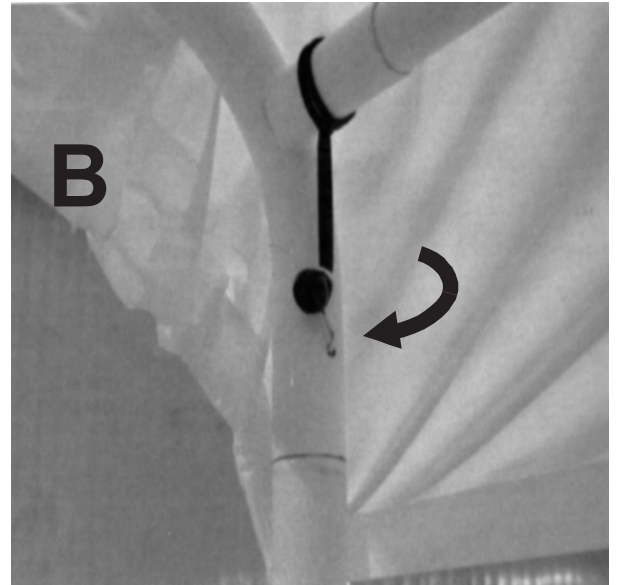

8. ATTACHING & SECURING BASE FEET

Insert Base Feet Plates onto bottom of legs, be sure to line up the pre-drilled hole in the leg with the pre-drilled hole in the base foot. Insert PIN all the way through leg and foot, to other side, secure with ring.

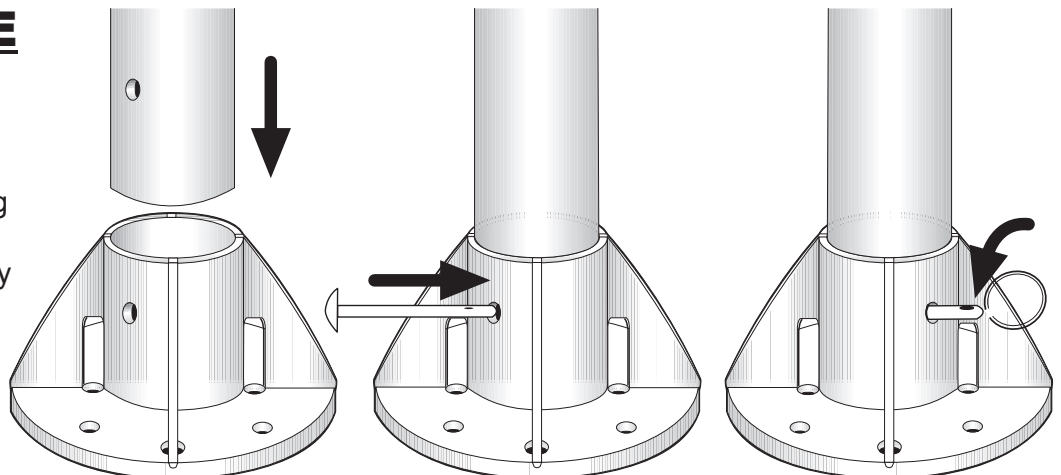

CARE & CLEANING INFORMATION

DO NOT expose top or walls to open fire or flame. **DO NOT** use barbeque grills or smokers underneath canopy.

DO NOT use harsh abrasives, bleach or cleansers. Cover and walls can be easily cleaned with mild soap and water. Periodically check stakes or anchors to ensure stability of unit, especially following exposure to high winds or heavy rain. **NOT** meant to hold snow load, brush snow off top with a broom or mop.

IMPORTANT:PLEASE READ CAREFULLY: North American Outdoor Products has no control over the elements such as wind, snow or heavy rain, we cannot be responsible for damage caused by the canopy or to the canopy. We suggest you contact your insurance carrier for information just as you would for any other outside structure.

This is a Temporary Structure and is not recommended as a permanent structure. Safety glasses must be worn when securing bungs.

Improper Anchoring, Strong Winds, Snow or Ice: North American Outdoor Products **does not guarantee these canopies in snow or ice under any circumstances.** Canopies are designed to offer protection from damage caused by sun, light rain, tree sap, birds, and are not designed to hold the loads that accompany snow or ice. Any canopy that is not anchored securely or properly will fly away. We will not be responsible for any canopy that blows away. proper anchoring is your responsibility. We offer several anchoring kits, call customer service for more information or to place an order. Your canopy's cover can be quickly removed if needed when you know that a strong or severe weather front is approaching.

CAUTION! WARNING!

Bungee cords are under extreme tension. Please use caution when applying as they may snap out of your hand and cause injury. The use of safety goggles may help to prevent injury.