

PACKING LIST FOR 10' x 10' CANOPY

NOTE: Canopy Dimensions Not Exact

<u>QTY.</u>	<u>PART No.</u>	<u>DESCRIPTION</u>	
1	T1012	TARP FOR 10' X 10'	
6	E3	3 WAY END PIECE	
34	BB6	BALL BUNGIES - 6"	
8	P58	5' 8" GALVANIZED POLES	
3	P50	5' GALVANIZED POLES	} When these two poles are put together they make a P59 - 9' 9" pole.
3	P50S	5' GALVANIZED POLES - SWAGED	

*Poles are 1.315" O. D.

**** NOTES ****

1. READ ALL INSTRUCTIONS BEFORE STARTING ASSEMBLY.
2. CANOPIES MUST BE SECURED DOWN (SEE OPTIONAL DETAILS ON PAGE 3)
3. NOT INTENDED FOR PERMANENT USE
4. TAKE TARP OFF BEFORE HEAVY SNOW
5. TAKE TARP OFF BEFORE HIGH WIND

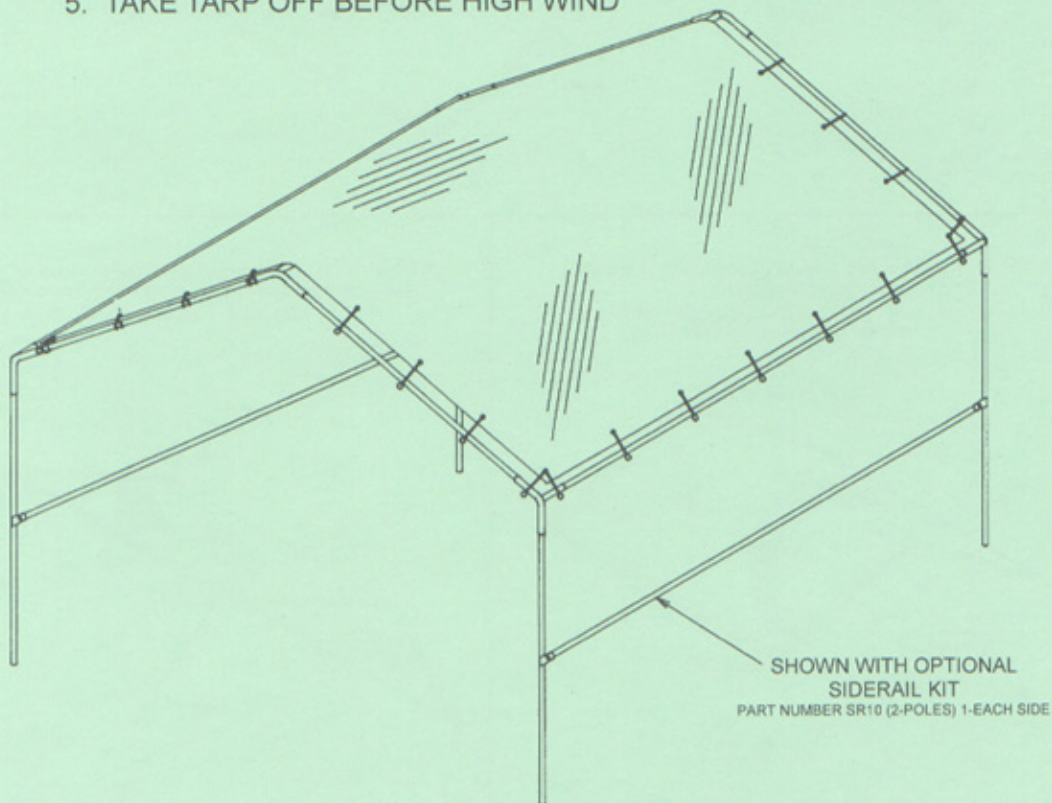

ASSEMBLY OF 10' x 10' CANOPY

Assembly of the canopy should be on a level sight and assembled in the following order.

WARNING: DO NOT USE FOR SNOW COVER.

STEP 1: a) Lay out the top section of the canopy on the ground as follows.

- b) Insert Part Number P99 into Part Number E3.
- c) Insert Part Number P58 into Part Number E3.

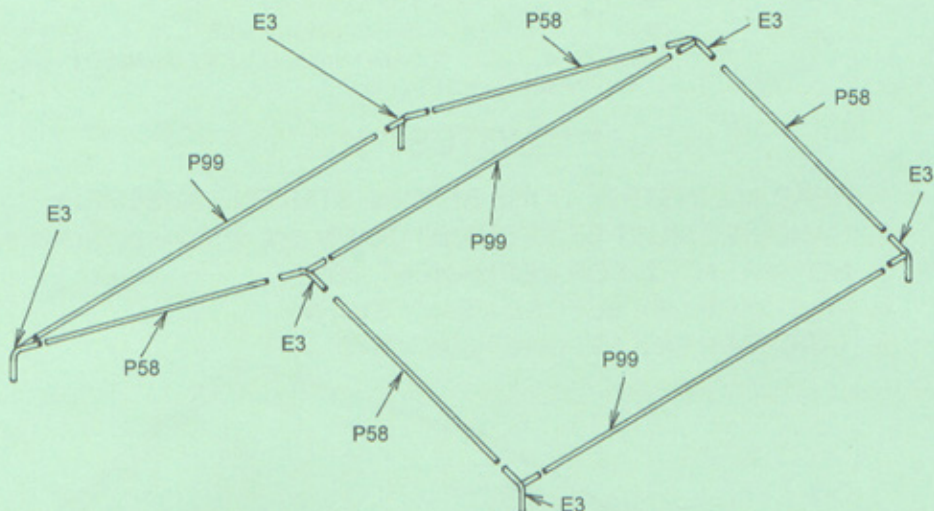

STEP 2: a) Extend tarp over assembly and attach Part Number BB.
"Tarp will only fit one way"

Note: Do opposite corners, then sides and top with Part Number BB.
"Only corners on ends get double bungie"

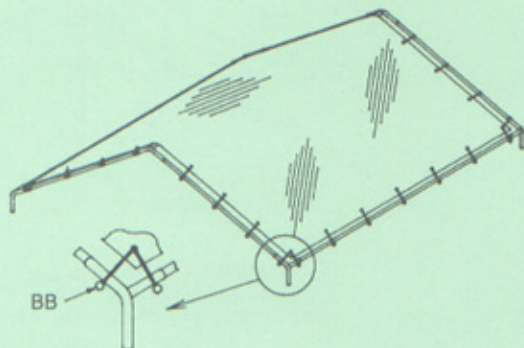

STEP 3: a) Insert Part Number P56 into Part Number E3.

Starting with one side and completing that side, then do the opposite side.

- b) Do not forget to secure canopy to ground.

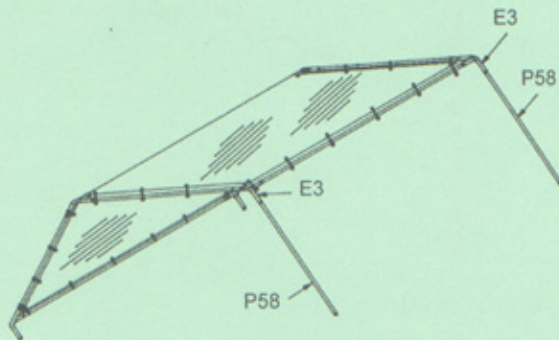

HELPFUL HINTS ON ASSEMBLY OF THE 10' x 10' CANOPY

1. Pick a good level spot to setup the All-Purpose Canopy.
2. If the tarp does not fit check the following:
 - a) Make sure poles are pushed firmly into all the 3-way end pieces.
 - b) If tarp is too short on the one side, then rotate 90 degrees.
3. Remove tarp or take down canopy before (SNOW & WIND STORMS) this will keep the tarp and poles in good condition.
4. Make sure canopy is secured from the 3-way ends down to the ground.
5. Enjoy!!

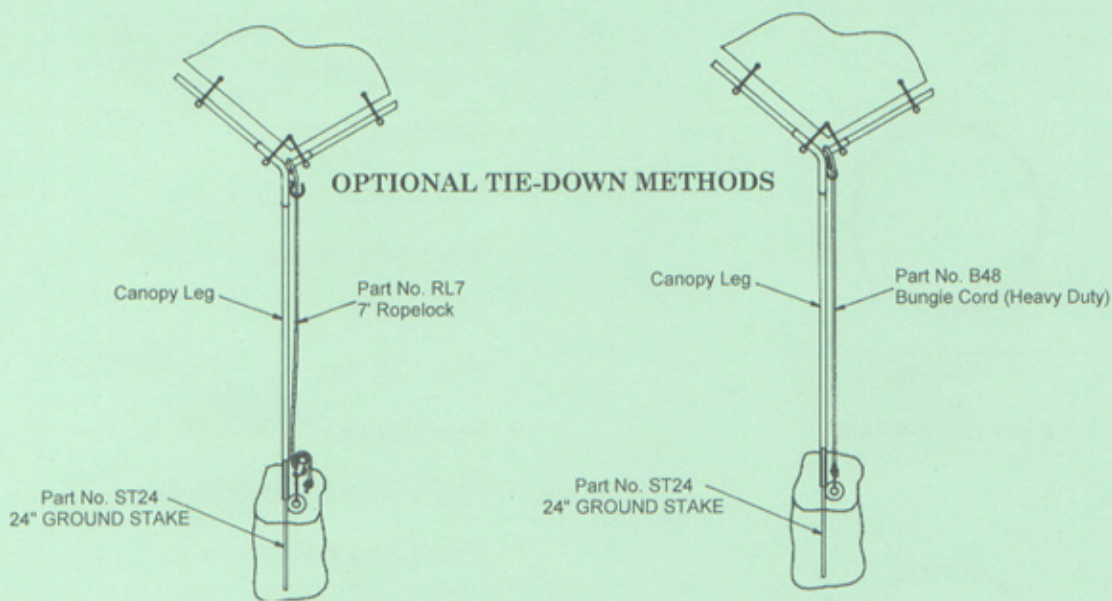

ALL PURPOSE CANOPY THIRTY DAY LIMITED WARRANTY

Harpster of Philipsburg promises to repair or replace the All Purpose Canopy or any part of it within thirty (30) days of purchase if defective in materials or workmanship. This limited warranty does not cover damage due to neglect, wind, snow, fire, misuse or any act of God, nor does this limited warranty cover damage resulting from the canopy not having been securely fastened down nor from improper installation. Harpster of Philipsburg makes no other warranty and the remedy of repair or replacement is the exclusive remedy. Harpster of Philipsburg, is not liable for indirect, incidental or consequential damages in connection with the use of the All Purpose Canopy, including any cost or expense of providing substitute equipment or service during periods of non-use. Any defective canopy or part must be sent, shipping pre-paid, to Harpster of Philipsburg, attention Warranty Department, 202 Airport Road, Philipsburg, Pennsylvania 16866.

EXCLUSION OF WARRANTIES

Harpster of Philipsburg makes no warranties which extend beyond the description on the face hereof. Specifically, the Warranty of Merchantability and the Warranty of Fitness for a Particular Purpose are Excluded. The only WARRANTY which is made by Harpster of Philipsburg is the "THIRTY DAY LIMITED WARRANTY" described above.

OPTIONAL ACCESSORIES

ASK YOUR LOCAL DEALER FOR FURTHER INFORMATION

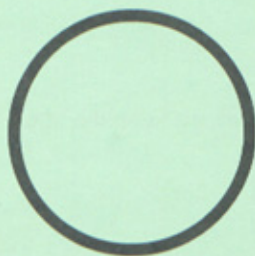

1.660" OD
16 GAUGE
COMMERCIAL FRAME

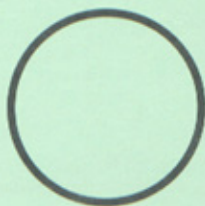

1.315" OD
17 GAUGE
HEAVY DUTY FRAME

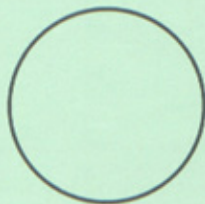

1.315" OD
20 GAUGE
STANDARD FRAME

REPLACEMENT PARTS & ACCESSORIES

- Gable End Panels
- Ground Stakes
- Replacement Poles
- Replacement Tarps
- Flag Holders
- Ball Bungies
- Ropelocks™
- Grommet Repair Kit
- End Clamp
- Boulevard Clamp
- Corner Clamp
- Side Rail Kits
- Side Panels
- Heavy Duty Bungie Cords
- 4" x 4" Leg Base Plate

CANOPY SIZES AVAILABLE:

10' x 10'	10' x 20'
18' x 20'	18' x 30'
12' x 30'	18' x 40'

www.harpster-canopies.com

Manufactured By: Harpster of Philipsburg, Inc. • P.O. Box 429 • 202 Airport Road • Philipsburg, PA 16866
Phone: (814) 342-2930 • Fax (814) 342-4193 • Email: sales@harpster-canopies.com

PACKING LIST FOR 10' x 20' CANOPY

NOTE: Canopy Dimensions Not Exact

QTY.	PART No.	DESCRIPTION	
1	T1220	TARP FOR 10' X 20'	
6	E3	3 WAY END PIECE	
3	C4	4 WAY CENTER PIECE	
50	BB	BALL BUNGIES	
6	P50	5' GALVANIZED POLES	} When these two poles are put together they make a P59 - 9' 9" pole.
6	P50S	5' GALVANIZED POLES - SWAGED	
12	P58	5' 8" GALVANIZED POLES	

*Poles are 1.315" O. D.

**** NOTES ****

1. READ ALL INSTRUCTIONS BEFORE STARTING ASSEMBLY.
2. CANOPIES MUST BE SECURED DOWN (SEE OPTIONAL DETAILS ON PAGE 3)
3. NOT INTENDED FOR PERMANENT USE
4. TAKE TARP OFF BEFORE HEAVY SNOW
5. TAKE TARP OFF BEFORE HIGH WIND

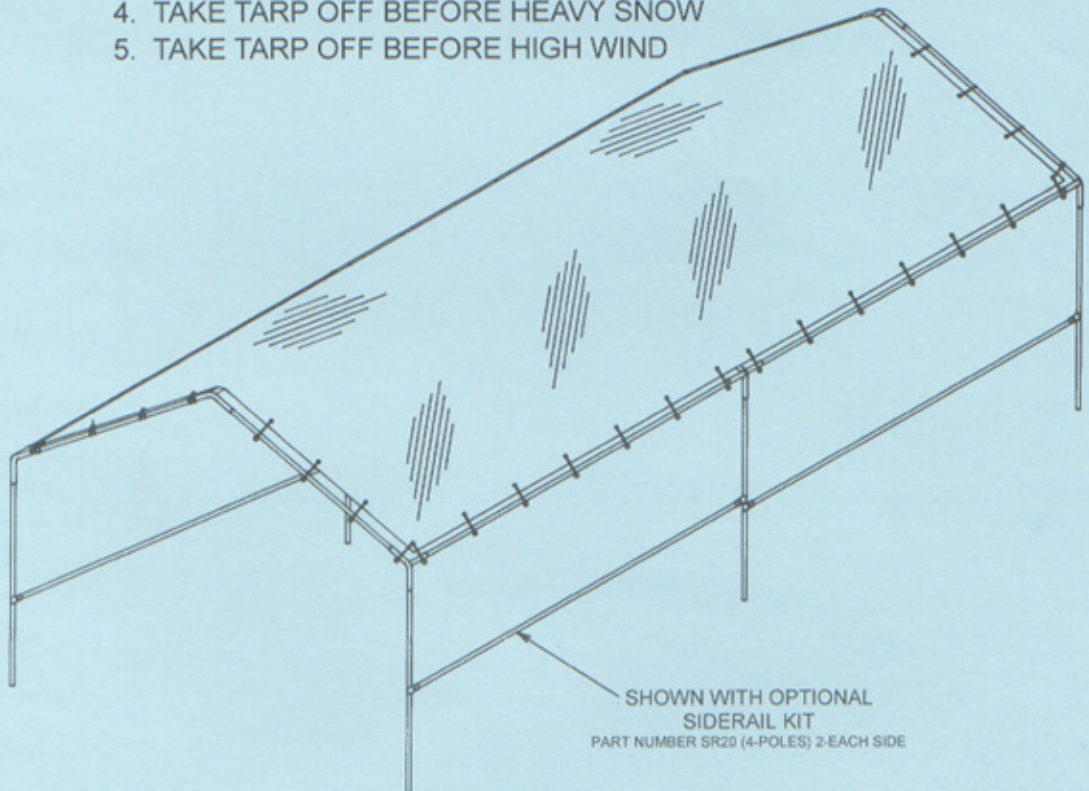

ASSEMBLY OF 10' x 20' CANOPY

Assembly of the canopy should be on a level sight and assembled in the following order.

WARNING: DO NOT USE FOR SNOW COVER.

STEP 1: a) Lay out the top section of the canopy on the ground as follows.

b) Insert Part Number P99 into Part Number E3 and C4.

c) Insert Part Number P58 into Part Number E3 and C4.

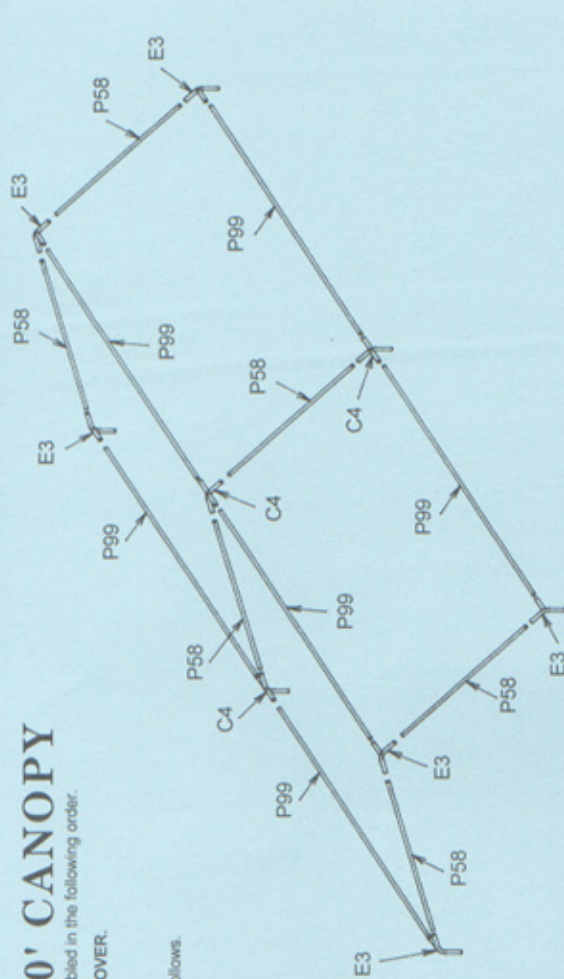

STEP 2: a) Extend tarp over assembly and attach Part Number BB.

"Tarp will only fit one way"

Note: Do opposite corners, then sides and top with Part Number BB.

"Only corners on ends get double bungie"

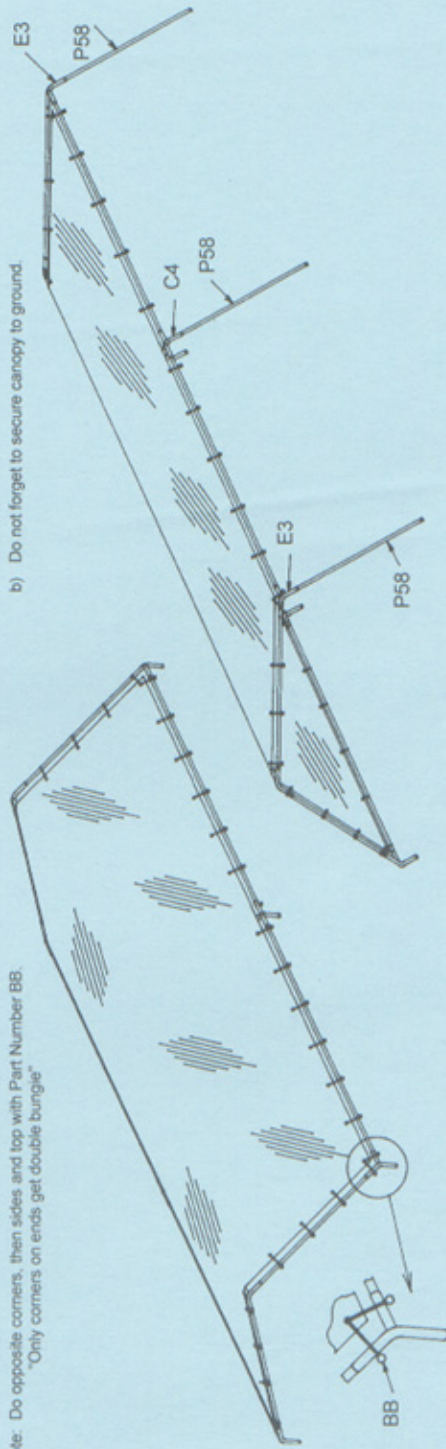

STEP 3: a) Insert Part Number P58 into Part Number E3 and C4.

Starting with one side and completing that side, then do the opposite side.

b) Do not forget to secure canopy to ground.

HELPFUL HINTS ON ASSEMBLY OF THE 10' x 20' CANOPY

1. Pick a good level spot to setup the All-Purpose Canopy.
2. If the tarp does not fit check the following:
 - a) Make sure poles are pushed firmly into all the 3-way end pieces and 4-way center pieces.
3. Remove tarp or take down canopy before (SNOW & WIND STORMS) this will keep the tarp and poles in good condition.
4. Make sure canopy is secured from the 3-way ends and 4-way centers down to the ground.
5. When putting legs on, start with the two center legs. The canopy will balance on those two legs, and complete that side. Do the same for the other side.
6. Enjoy!!

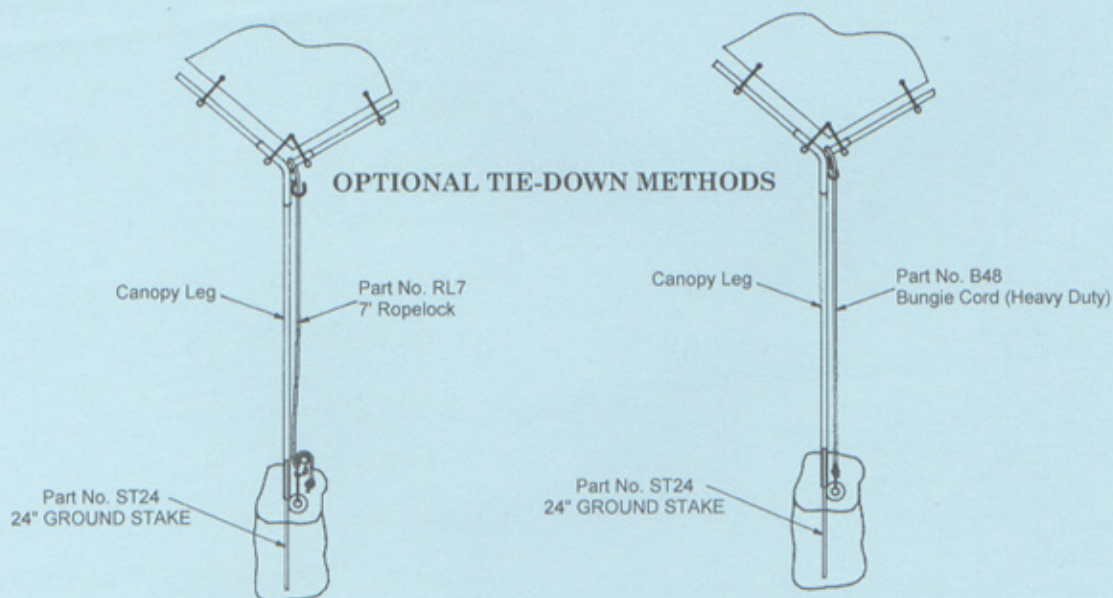

ALL PURPOSE CANOPY THIRTY DAY LIMITED WARRANTY

Harpster of Philipsburg promises to repair or replace the All Purpose Canopy or any part of it within thirty (30) days of purchase if defective in materials or workmanship. This limited warranty does not cover damage due to neglect, wind, snow, fire, misuse or any act of God, nor does this limited warranty cover damage resulting from the canopy not having been securely fastened down nor from improper installation. Harpster of Philipsburg makes no other warranty and the remedy of repair or replacement is the exclusive remedy. Harpster of Philipsburg, is not liable for indirect, incidental or consequential damages in connection with the use of the All Purpose Canopy, including any cost or expense of providing substitute equipment or service during periods of non-use. Any defective canopy or part must be sent, shipping pre-paid, to Harpster of Philipsburg, attention Warranty Department, 408 Airport Road, Philipsburg, Pennsylvania 16866.

EXCLUSION OF WARRANTIES

Harpster of Philipsburg makes no warranties which extend beyond the description on the face hereof. Specifically, the Warranty of Merchantability and the Warranty of Fitness for a Particular Purpose are Excluded. The only WARRANTY which is made by Harpster of Philipsburg is the "THIRTY DAY LIMITED WARRANTY" described above.

www.harpster-canopies.com

Harpster of Philipsburg, Inc. • P.O. Box 429 • 408 Airport Road • Philipsburg, PA 16866 Phone: (814) 342-2930 • Fax (814) 342-4193 • Email: sales@harpster-canopies.com

PAGE 3

OPTIONAL ACCESSORIES

ASK YOUR LOCAL DEALER FOR FURTHER INFORMATION

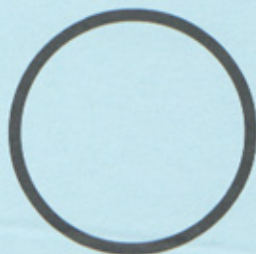

1.660" OD
16 GAUGE
COMMERCIAL FRAME



1.315" OD
17 GAUGE
HEAVY DUTY FRAME

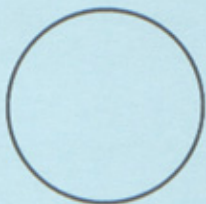

1.315" OD
20 GAUGE
STANDARD FRAME

REPLACEMENT PARTS & ACCESSORIES

- Gable End Panels
- Ground Stakes
- Replacement Poles
- Replacement Tarps
- Flag Holders
- Ball Bungies
- Ropelocks™
- Grommet Repair Kit
- End Clamp
- Boulevard Clamp
- Corner Clamp
- Side Rail Kits
- Side Panels
- Heavy Duty Bungie Cords
- 4" x 4" Leg Base Plate

CANOPY SIZES AVAILABLE:

10' x 10'	10' x 20'
18' x 20'	18' x 30'
12' x 30'	18' x 40'

www.harpster-canopies.com

Manufactured By: Harpster of Phillipsburg, Inc. • P.O. Box 429 • 408 Airport Road • Phillipsburg, PA 16866
Phone: (814) 342-2930 • Fax (814) 342-4193 • Email: sales@harpster-canopies.com

PAGE 4

PACKING LIST FOR 12' x 30' CANOPY

NOTE: Canopy Dimensions Not Exact

QTY.	PART No.	DESCRIPTION
1	T1530	TARP FOR 12' X 30'
6	E3	3 WAY END PIECE
6	C4	4 WAY CENTER PIECE
65	BB	BALL BUNGIES
8	P58	5' 8" GALVANIZED POLES
9	P50S	5' GALVANIZED POLES — SWAGED
9	P50	5' GALVANIZED POLES
8	P611	6' 11" GALVANIZED POLES

When these two poles are put together they make a P99 - 9' 9" pole

*Poles are 1.315" O. D.

***** NOTES *****

1. READ ALL INSTRUCTIONS BEFORE STARTING ASSEMBLY.
2. CANOPIES MUST BE SECURED DOWN (SEE OPTIONAL DETAILS ON PAGE 4)
3. NOT INTENDED FOR PERMANENT USE
4. TAKE TARP OFF BEFORE HEAVY SNOW
5. TAKE TARP OFF BEFORE HIGH WIND

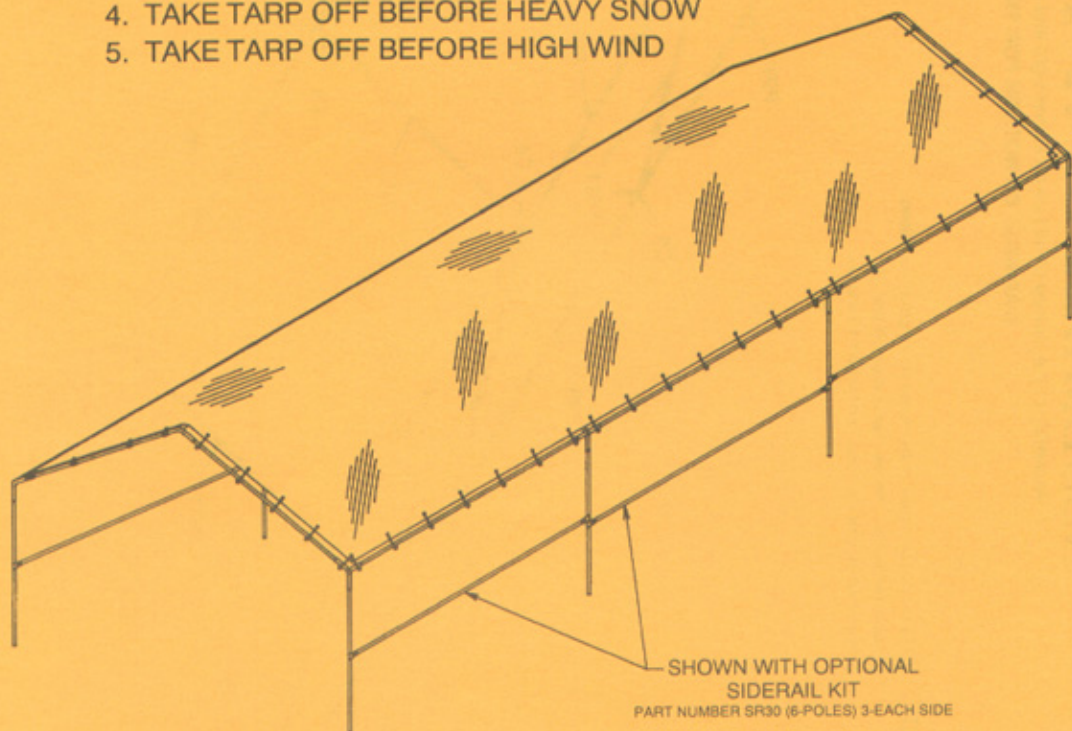

SHOWN WITH OPTIONAL
SIDERAIL KIT
PART NUMBER SR30 (6-POLES) 3-EACH SIDE

ASSEMBLY OF 12' x 30' CANOPY

Assembly of the canopy should be on a level sight and assembled in the following order.

WARNING: DO NOT USE FOR SNOW COVER.

- STEP 1:**
- Lay out the top section of the canopy on the ground as follows.
 - Insert Part Number P99 into Part Number E3 and C4.
 - Insert Part Number P611 into Part Number E3 and C4.

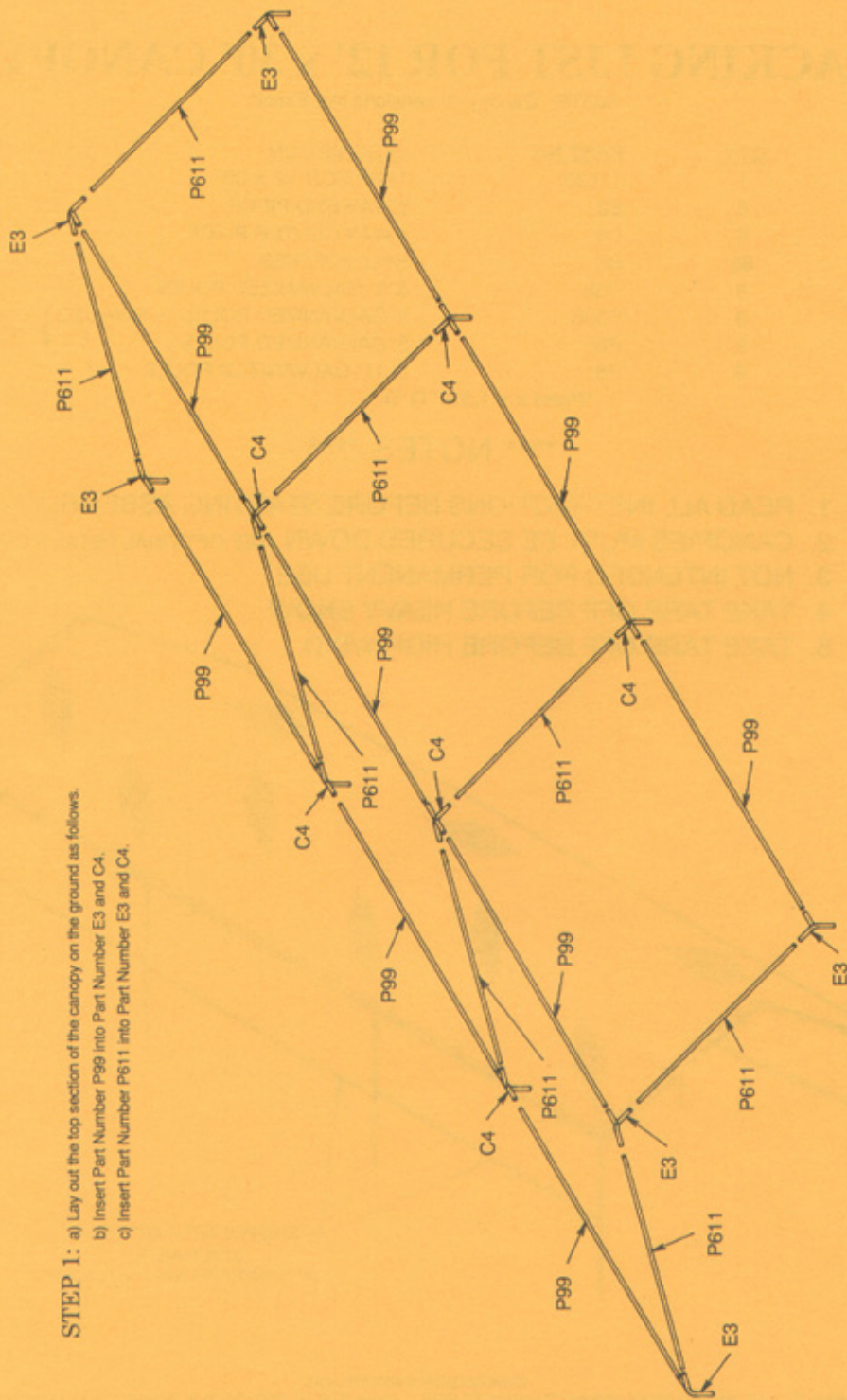

ASSEMBLY OF 12' x 30' CANOPY

Assembly of the canopy should be on a level sight and assembled in the following order.

STEP 2: a) Extend tarp over assembly and attach Part Number BB.
"Tarp will only fit one way"

Note: Do opposite corners, then sides and top with Part Number BB.
"Only corners on ends get double bungie"

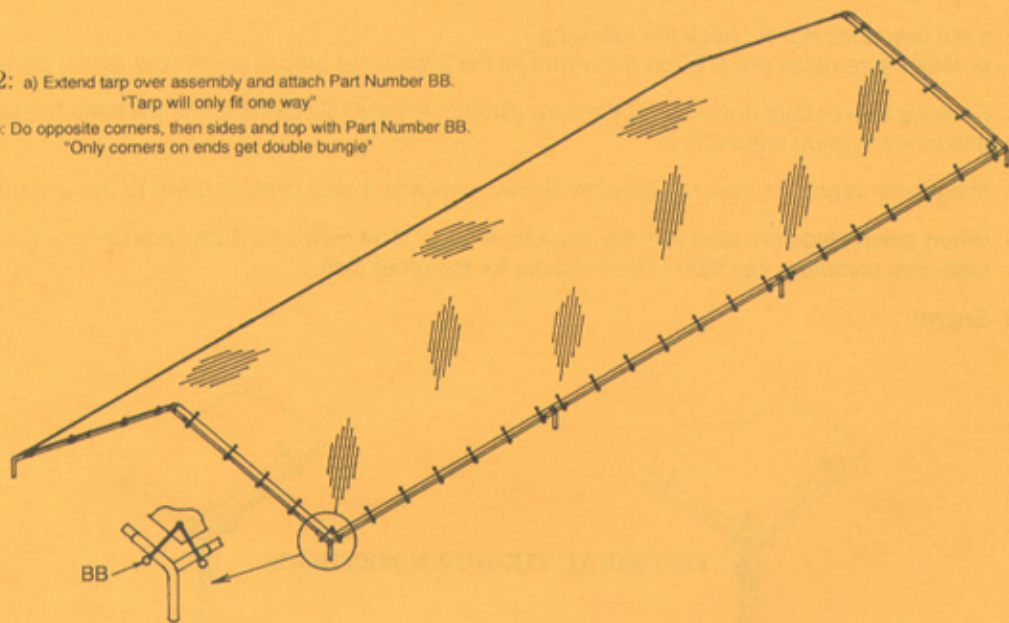

STEP 3: a) Insert Part Number P58 into Part Number E3 and C4.

Start with one side and completing that side, then do the opposite side

b) Do not forget to secure canopy to ground.

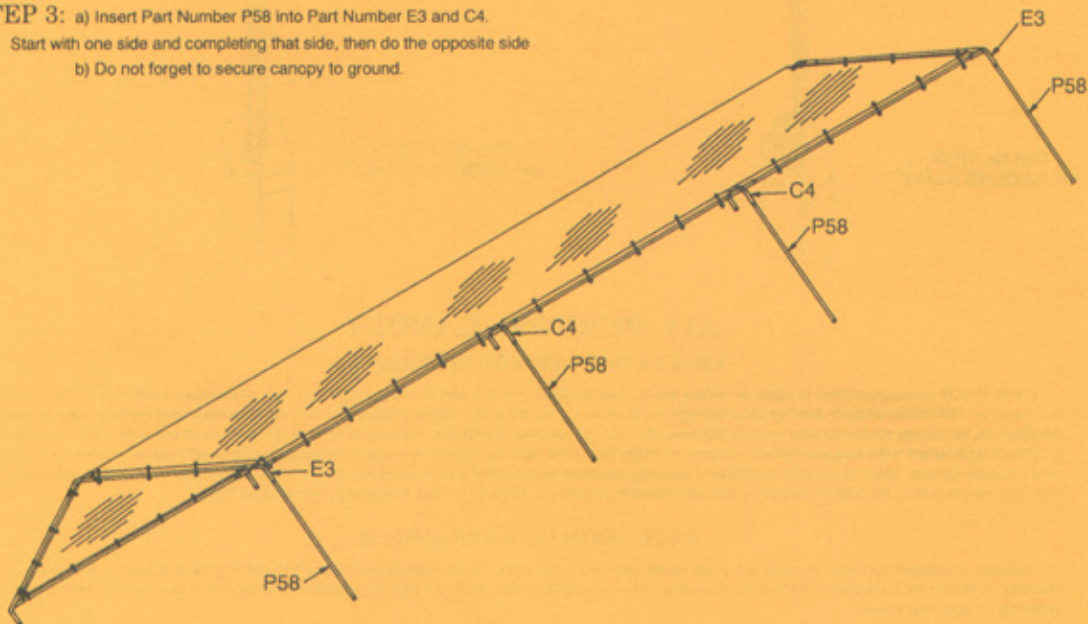

HELPFUL HINTS ON ASSEMBLY OF THE 12' x 30' CANOPY

1. Pick a good level spot to setup the All-Purpose Canopy.
2. If the tarp does not fit check the following:
 - a) Make sure poles are pushed firmly into all the 3-way end pieces and 4-way center pieces.
3. Remove tarp or take down canopy before (SNOW & WIND STORMS) this will keep the tarp and poles in good condition.
4. Make sure canopy is secured from the 3-way ends and 4-way centers down to the ground.
5. When putting legs on, start with the two center legs. The canopy will balance on those two legs, and complete that side. Do the same for the other side.
6. Enjoy!!

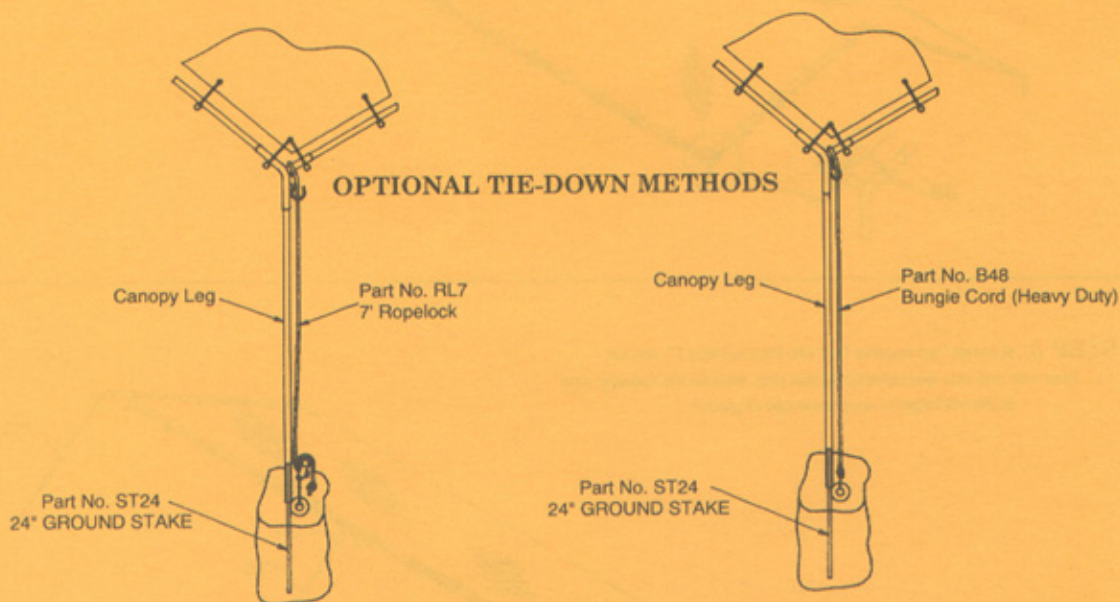

ALL PURPOSE CANOPY THIRTY DAY LIMITED WARRANTY

Harpster of Philipsburg promises to repair or replace the All Purpose Canopy or any part of it within thirty (30) days of purchase if defective in materials or workmanship. This limited warranty does not cover damage due to neglect, wind, snow, fire, misuse or any act of God, nor does this limited warranty cover damage resulting from the canopy not having been securely fastened down nor from improper installation. Harpster of Philipsburg makes no other warranty and the remedy of repair or replacement is the exclusive remedy. Harpster of Philipsburg, is not liable for indirect, incidental or consequential damages in connection with the use of the All Purpose Canopy, including any cost or expense of providing substitute equipment or service during periods of non-use. Any defective canopy or part must be sent, shipping pre-paid, to Harpster of Philipsburg, attention Warranty Department, 408 Airport Road, Philipsburg, Pennsylvania 16866.

EXCLUSION OF WARRANTIES

Harpster of Philipsburg makes no warranties which extend beyond the description on the face hereof. Specifically, the Warranty of Merchantability and the Warranty of Fitness for a Particular Purpose are Excluded. The only WARRANTY which is made by Harpster of Philipsburg is the "THIRTY DAY LIMITED WARRANTY" described above.

PACKING LIST FOR 18' x 20' CANOPY

NOTE: Canopy Dimensions Not Exact

<u>QTY.</u>	<u>PART No.</u>	<u>DESCRIPTION</u>	
1	T2020	TARP FOR 18' X 20'	
6	E3	3 WAY END PIECE	
3	C4	4 WAY CENTER PIECE	
60	BB	BALL BUNGIES	
12	P50	5' GALVANIZED POLES	} When these two poles are put together they make a P99 - 9' 9" pole.
12	P50S	5' GALVANIZED POLES	
6	P58	5' 8" GALVANIZED POLES	

*Poles are 1.315" O. D.

**** NOTES ****

1. READ ALL INSTRUCTIONS BEFORE STARTING ASSEMBLY.
2. CANOPIES MUST BE SECURED DOWN (SEE OPTIONAL DETAILS ON PAGE 4)
3. NOT INTENDED FOR PERMANENT USE
4. TAKE TARP OFF BEFORE HEAVY SNOW
5. TAKE TARP OFF BEFORE HIGH WIND

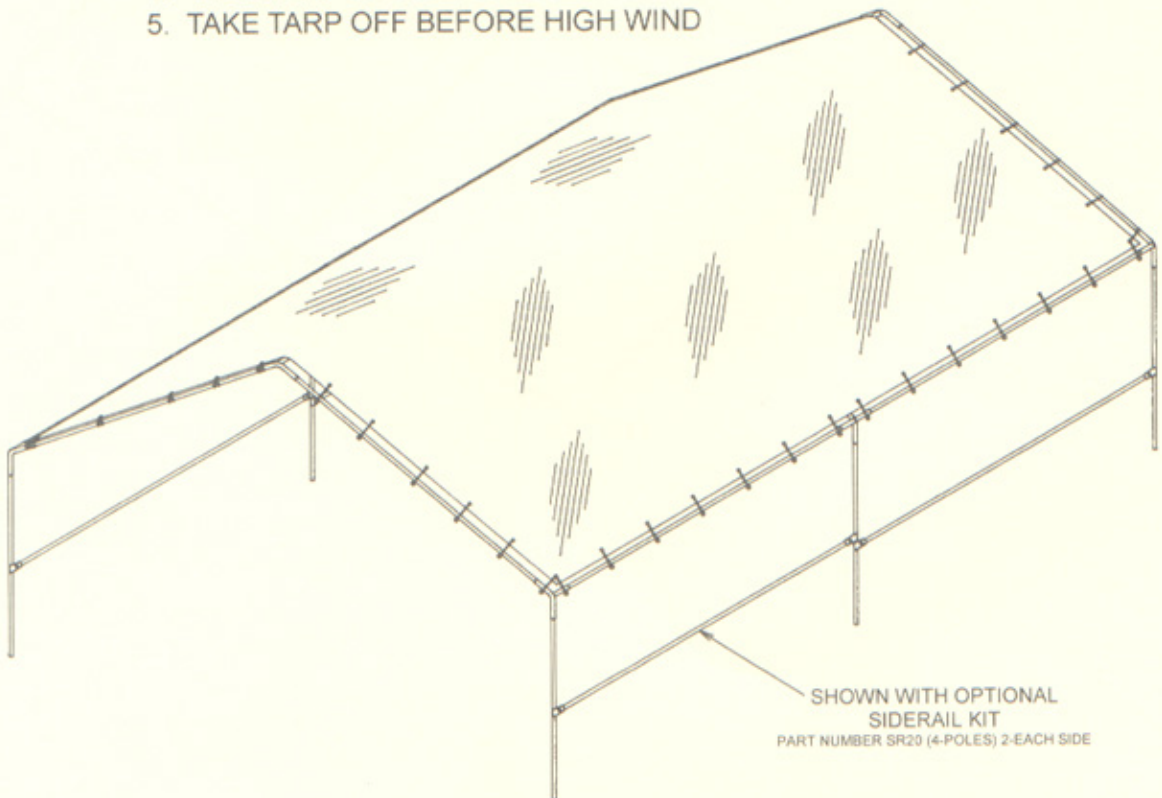

ASSEMBLY OF 18' x 20' CANOPY

Assembly of the canopy should be on a level sight and assembled in the following order.

WARNING: DO NOT USE FOR SNOW COVER.

- STEP 1:** a) Lay out the top section of the canopy on the ground as follows.
b) Insert Part Number P99 into Part Number E3 and E4.

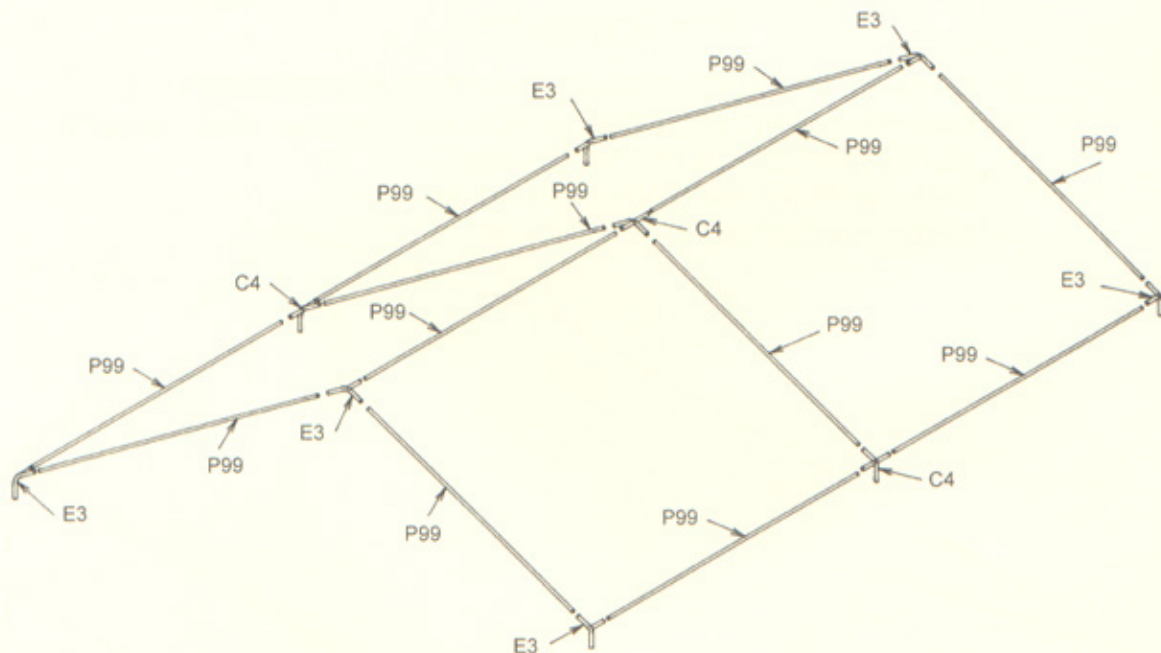

ASSEMBLY OF 18' x 20' CANOPY

Assembly of the canopy should be on a level sight and assembled in the following order.

STEP 2: a) Extend tarp over assembly and attach Part Number BB.

"Tarp will only fit one way"

1. Do opposite corners, then sides and top with Part Number BB.
"Only corners on ends get double bungie"
2. Ball Bungie may have to be wrapped around pole twice to eliminate slack.

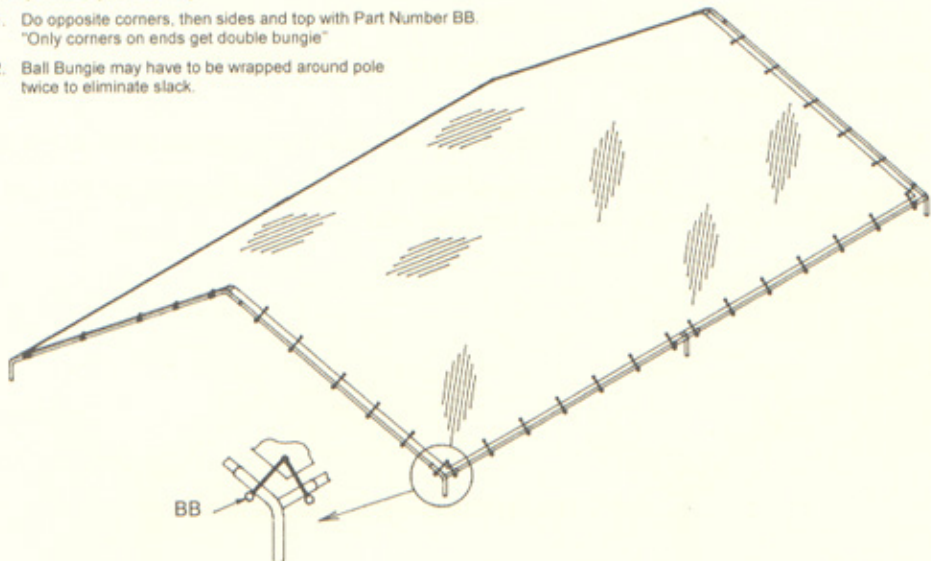

STEP 3: a) Insert Part Number P58 into Part Number E3 and C4.

Start with one side and completing that side, then do the opposite side

- b) Do not forget to secure canopy to ground.

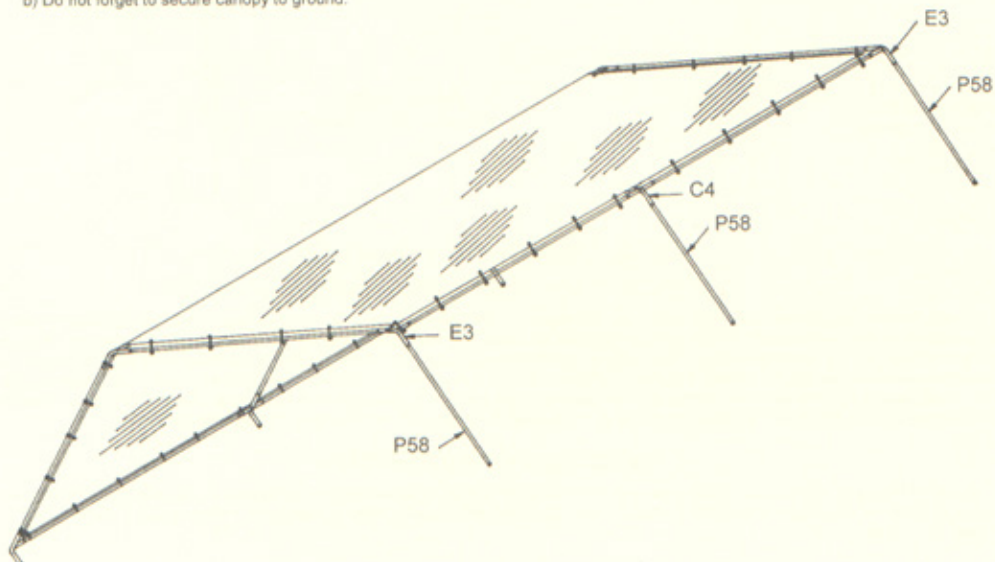

HELPFUL HINTS ON ASSEMBLY OF THE 18' x 20' CANOPY

1. Pick a good level spot to setup the All-Purpose Canopy.
2. If the tarp does not fit check the following:
 - a) Make sure poles are pushed firmly into all the 3-way end pieces and 4-way center pieces.
 - b) If tarp is too short on the one side, then rotate 90 degrees.
3. Remove tarp or take down canopy before (SNOW & WIND STORMS) this will keep the tarp and poles in good condition.
4. Make sure canopy is secured from the 3-way ends and 4-way centers down to the ground.
5. When putting legs on, start with the center leg. The canopy will balance on that one leg, and complete that side. Do the same for the other side.
6. Enjoy!!

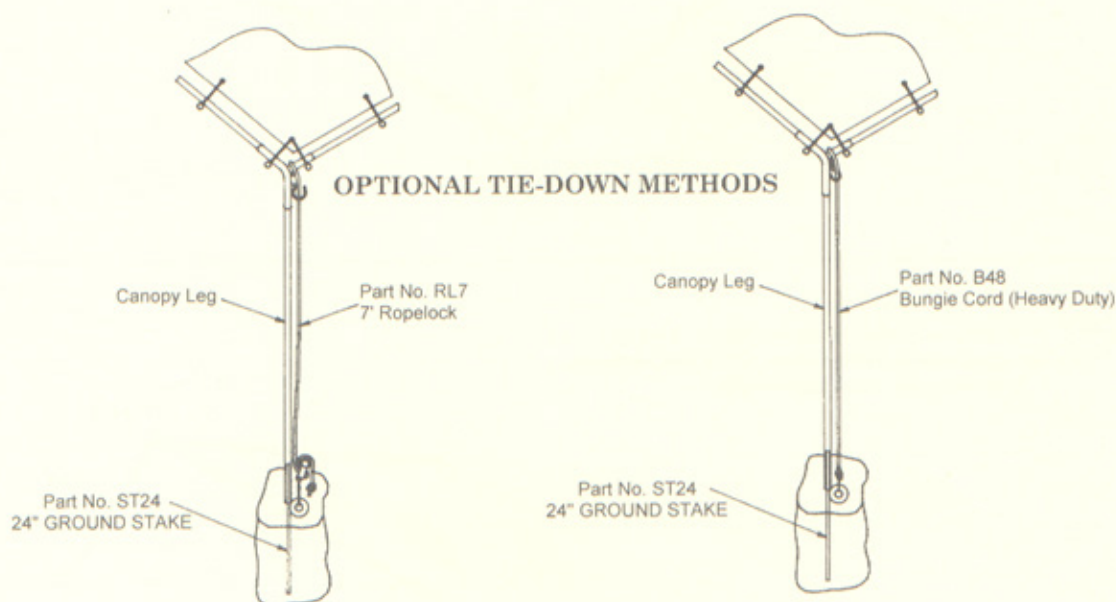

ALL PURPOSE CANOPY THIRTY DAY LIMITED WARRANTY

Harpster of Philipsburg promises to repair or replace the All Purpose Canopy or any part of it within thirty (30) days of purchase if defective in materials or workmanship. This limited warranty does not cover damage due to neglect, wind, snow, fire, misuse or any act of God, nor does this limited warranty cover damage resulting from the canopy not having been securely fastened down nor from improper installation. Harpster of Philipsburg makes no other warranty and the remedy of repair or replacement is the exclusive remedy. Harpster of Philipsburg, is not liable for indirect, incidental or consequential damages in connection with the use of the All Purpose Canopy, including any cost or expense of providing substitute equipment or service during periods of non-use. Any defective canopy or part must be sent, shipping pre-paid, to Harpster of Philipsburg, attention Warranty Department, 202 Airport Road, Philipsburg, Pennsylvania 16866.

EXCLUSION OF WARRANTIES

Harpster of Philipsburg makes no warranties which extend beyond the description on the face hereof. Specifically, the Warranty of Merchantability and the Warranty of Fitness for a Particular Purpose are Excluded. The only WARRANTY which is made by Harpster of Philipsburg is the "THIRTY DAY LIMITED WARRANTY" described above.

www.harpster-canopies.com

Harpster of Philipsburg, Inc. • P.O. Box 429 • 202 Airport Road • Philipsburg, PA 16866 Phone: (814) 342-2930 • Fax (814) 342-4193 • Email: sales@harpster-canopies.com

PACKING LIST FOR 18' x 30' CANOPY

NOTE: Canopy Dimensions Not Exact

QTY.	PART No.	DESCRIPTION	
1	T2030	TARP FOR 18 X 30	
6	E3	3 WAY END PIECE	
6	C4	4 WAY CENTER PIECE	
72	BB	BALL BUNGIES	
8	P58HD	5' 8" GALVANIZED POLES	} When these two poles are put together they make a P99HD - 9' 9" pole.
17	P50SHD	5' GALVANIZED POLES - SWAGED	
17	P50HD	5' GALVANIZED POLES	

*Poles are 1.315" O. D.

**** NOTES ****

1. READ ALL INSTRUCTIONS BEFORE STARTING ASSEMBLY.
2. CANOPIES MUST BE SECURED DOWN (SEE OPTIONAL DETAILS ON PAGE 4)
3. NOT INTENDED FOR PERMANENT USE
4. TAKE TARP OFF BEFORE HEAVY SNOW
5. TAKE TARP OFF BEFORE HIGH WIND

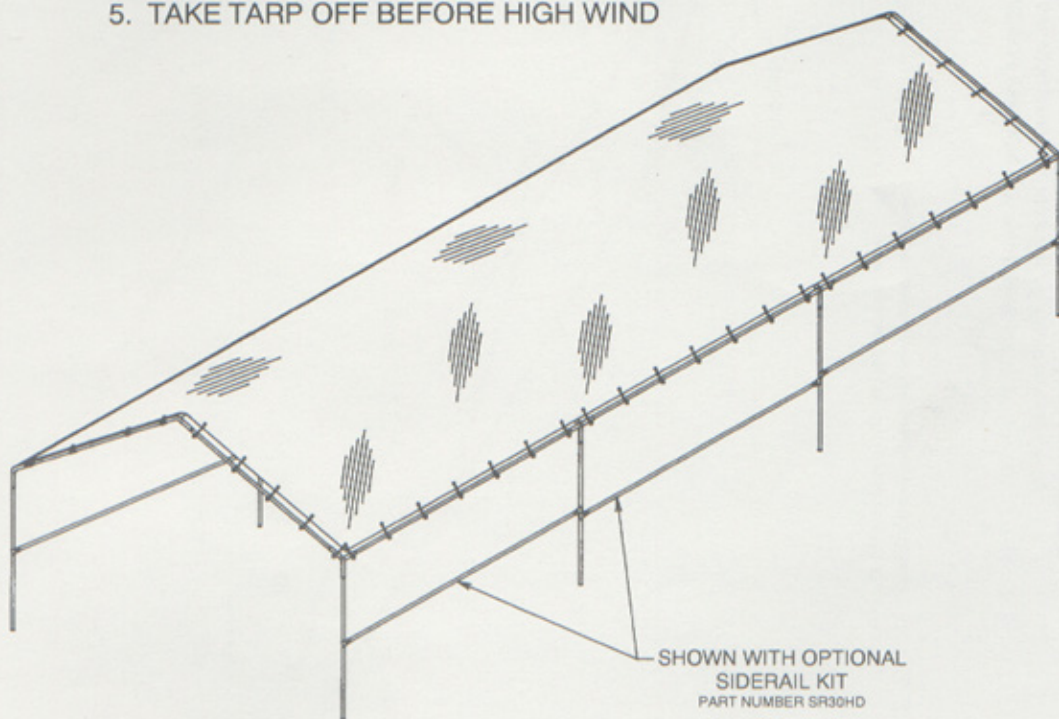

ASSEMBLY OF 18' x 30' CANOPY

Assembly of the canopy should be on a level sight and assembled in the following order.

WARNING: DO NOT USE FOR SNOW COVER.

- STEP 1:** a) Lay out the top section of the canopy on the ground as follows.
b) Insert Part Number P99HD into Part Number E3 and C4.

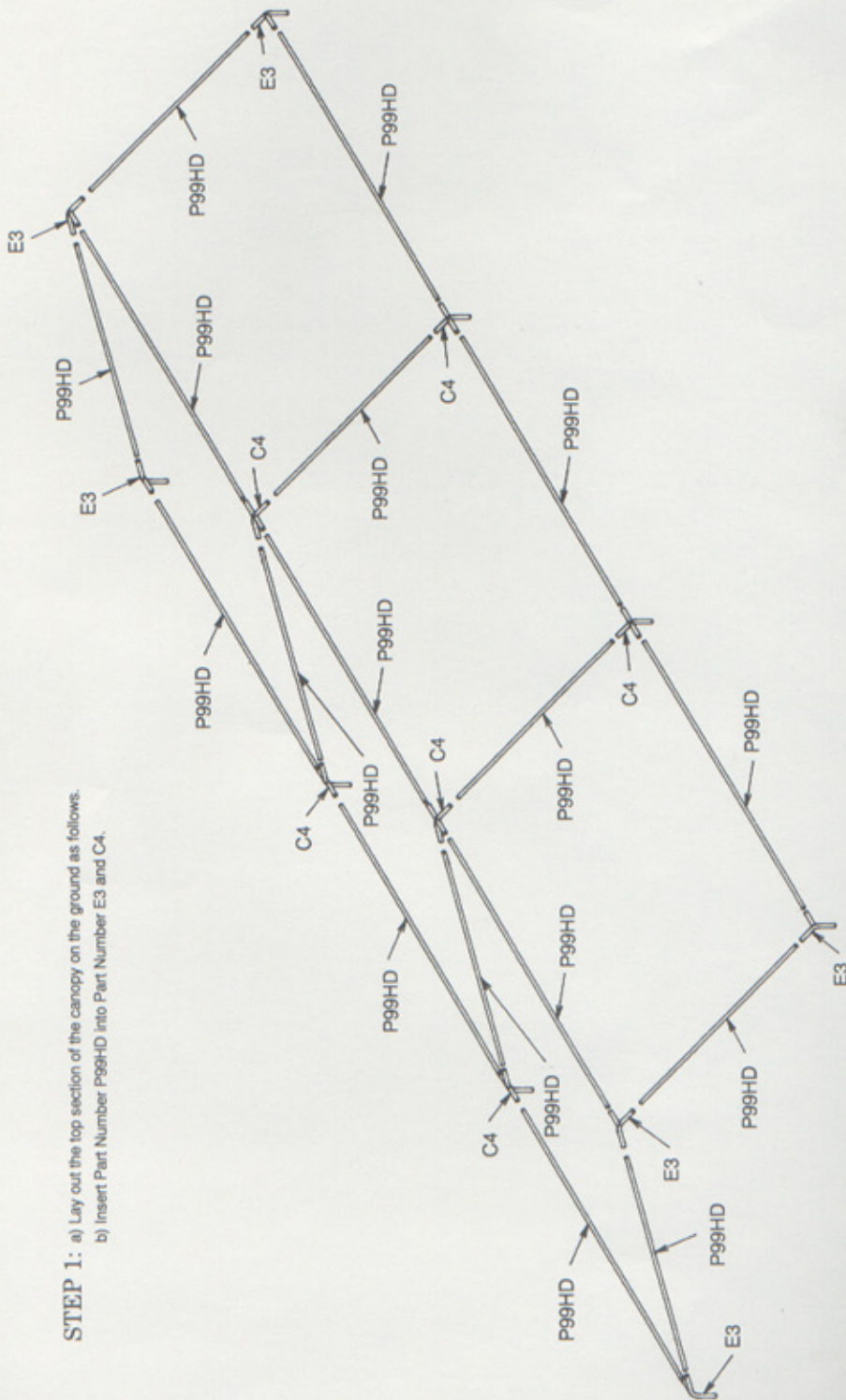

ASSEMBLY OF 18' x 30' CANOPY

Assembly of the canopy should be on a level sight and assembled in the following order.

STEP 2: a) Extend tarp over assembly and attach Part Number BB.

"Tarp will only fit one way"

Note: Do opposite corners, then sides and top with Part Number BB.
"Only corners on ends get double bungle"

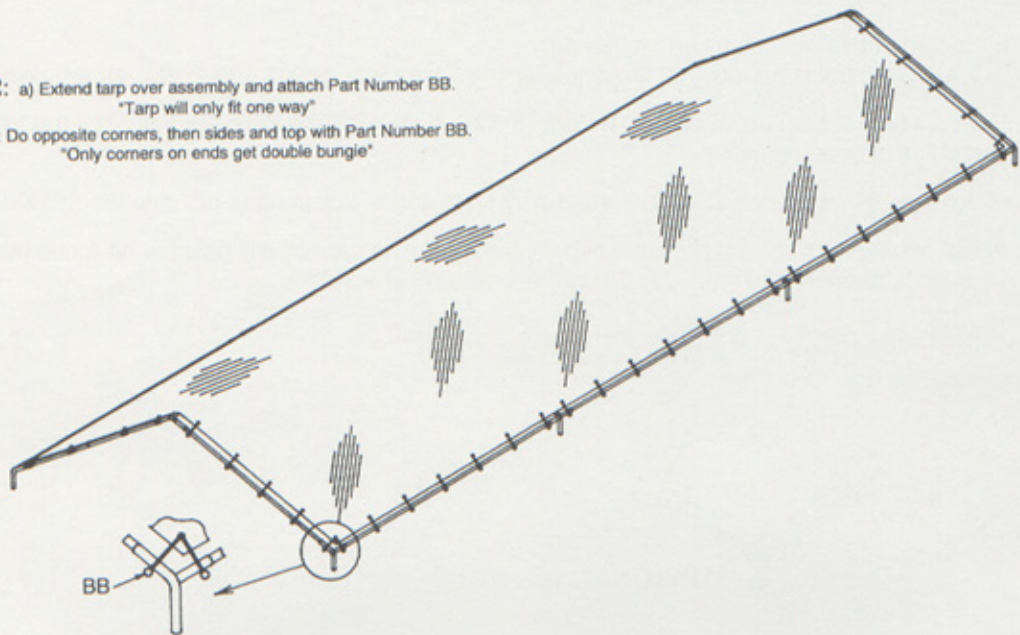

STEP 3: a) Insert Part Number P58HD into Part Number E3 and C4.

Start with one side and completing that side, then do the opposite side

b) Do not forget to secure canopy to ground.

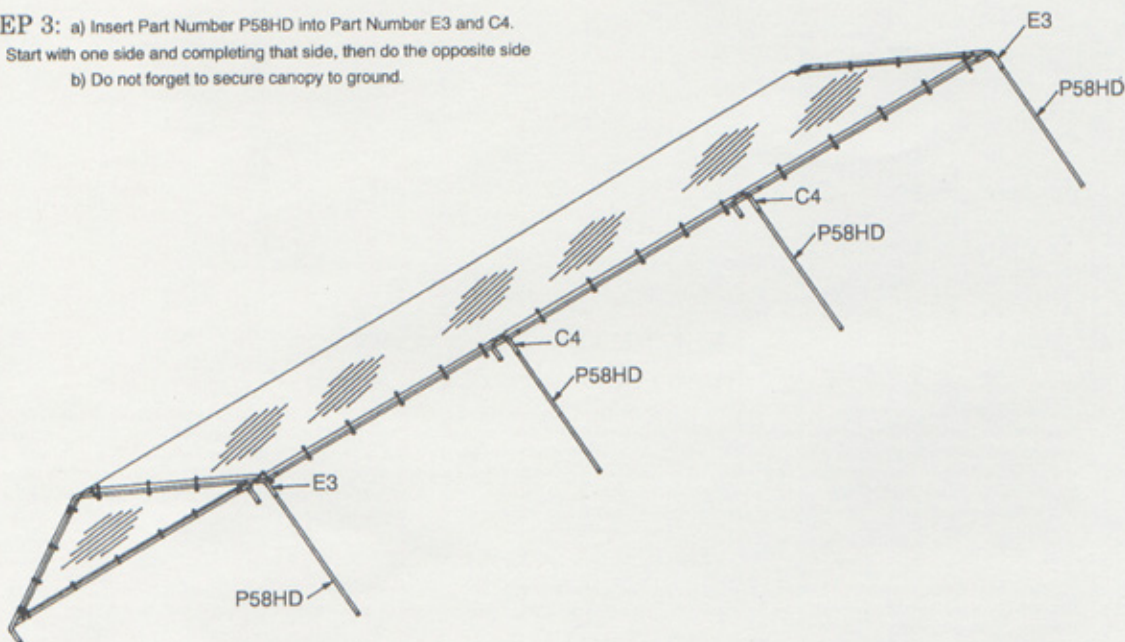

HELPFUL HINTS ON ASSEMBLY OF THE 18' x 30' CANOPY

1. Pick a good level spot to setup the All-Purpose Canopy.
2. If the tarp does not fit check the following:
 - a) Make sure poles are pushed firmly into all the 3-way end pieces and 4-way center pieces.
3. Remove tarp or take down canopy before (SNOW & WIND STORMS) this will keep the tarp and poles in good condition.
4. Make sure canopy is secured from the 3-way ends and 4-way centers down to the ground.
5. When putting legs on, start with the two center legs. The canopy will balance on those two legs, and complete that side. Do the same for the other side.
6. Enjoy!!

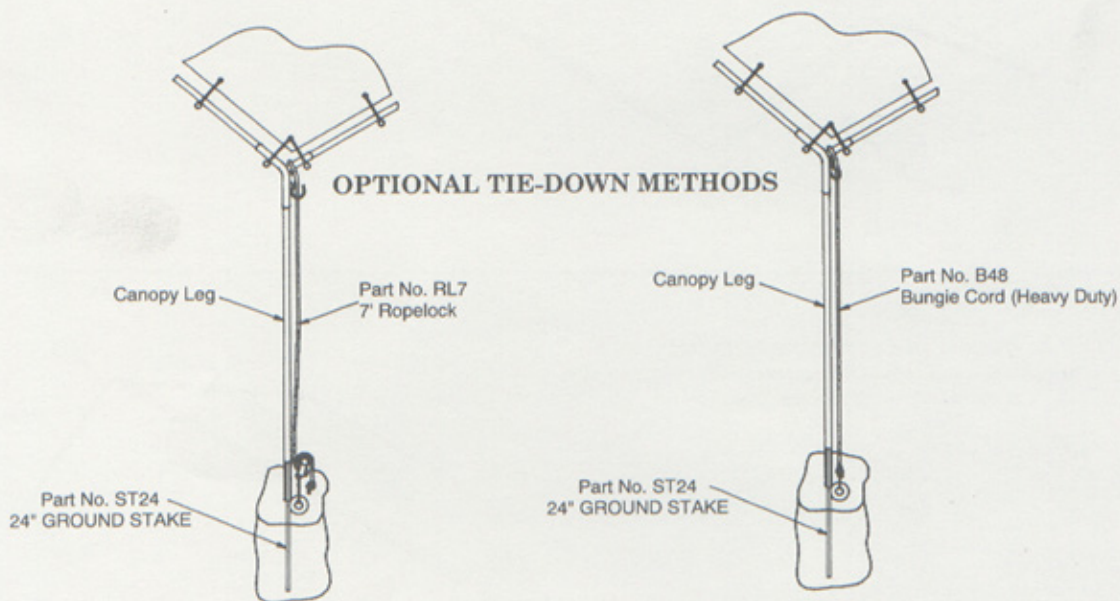

ALL PURPOSE CANOPY THIRTY DAY LIMITED WARRANTY

Harpster of Philipsburg promises to repair or replace the All Purpose Canopy or any part of it within thirty (30) days of purchase if defective in materials or workmanship. This limited warranty does not cover damage due to neglect, wind, snow, fire, misuse or any act of God, nor does this limited warranty cover damage resulting from the canopy not having been securely fastened down nor from improper installation. Harpster of Philipsburg makes no other warranty and the remedy of repair or replacement is the exclusive remedy. Harpster of Philipsburg, is not liable for indirect, incidental or consequential damages in connection with the use of the All Purpose Canopy, including any cost or expense of providing substitute equipment or service during periods of non-use. Any defective canopy or part must be sent, shipping pre-paid, to Harpster of Philipsburg, attention Warranty Department, 408 Airport Road, Philipsburg, Pennsylvania 16866.

EXCLUSION OF WARRANTIES

Harpster of Philipsburg makes no warranties which extend beyond the description on the face hereof. Specifically, the Warranty of Merchantability and the Warranty of Fitness for a Particular Purpose are Excluded. The only WARRANTY which is made by Harpster of Philipsburg is the "THIRTY DAY LIMITED WARRANTY" described above.

www.harpster-canopies.com

Harpster of Philipsburg, Inc. • P.O. Box 429 • 408 Airport Road • Philipsburg, PA 16866 Phone: (814) 342-2930 • Fax (814) 342-4193 • Email: sales@harpster-canopies.com

PAGE 4

PACKING LIST FOR 18' x 40' CANOPY

NOTE: Canopy Dimensions Not Exact

QTY.	PART No.	DESCRIPTION
1	T2040	TARP FOR 18 X 40
6	E3	3 WAY END PIECE
9	C4	4 WAY CENTER PIECE
100	BB	BALL BUNGIES
10	P58HD	5' 8" GALVANIZED POLES
22	P50SHD	5' GALVANIZED POLES
22	P50HD	5' GALVANIZED POLES

When these two poles are put together they make a P99HD - 9' 9" pole.

*Poles are 1.315" O. D.

**** NOTES ****

1. READ ALL INSTRUCTIONS BEFORE STARTING ASSEMBLY.
2. CANOPIES MUST BE SECURED DOWN (SEE OPTIONAL DETAILS ON PAGE 4)
3. NOT INTENDED FOR PERMANENT USE
4. TAKE TARP OFF BEFORE HEAVY SNOW
5. TAKE TARP OFF BEFORE HIGH WIND

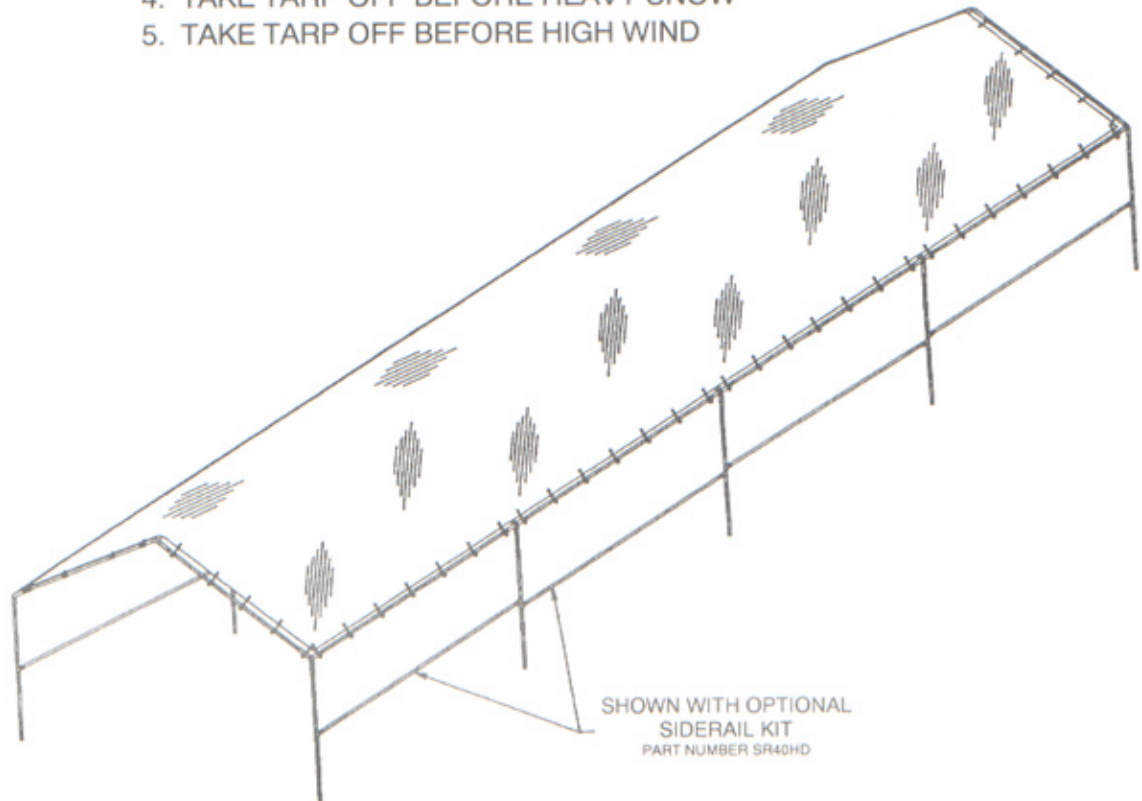

SHOWN WITH OPTIONAL
SIDERAIL KIT
PART NUMBER SR40HD

ASSEMBLY OF 18' X 40' CANOPY

Assembly of the canopy should be on a level site and assembled in the following order.

WARNING: DO NOT USE FOR SNOW COVER.

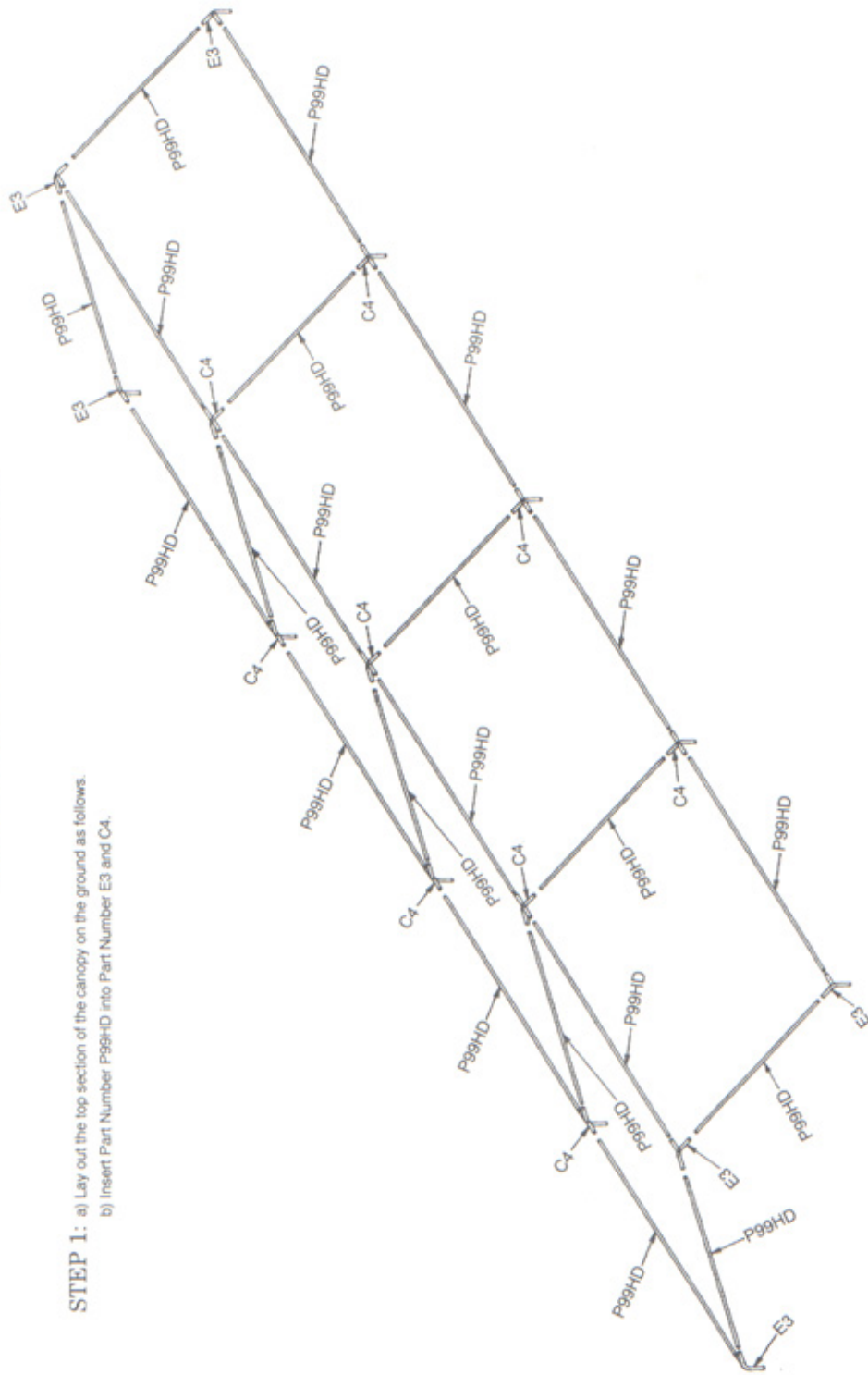

- STEP 1:** a) Lay out the top section of the canopy on the ground as follows.
b) Insert Part Number P99HD into Part Number E3 and C4.

ASSEMBLY OF 18' x 40' CANOPY

Assembly of the canopy should be on a level site and assembled in the following order.

STEP 2: a) Extend tarp over assembly and attach Part Number BB.
"Tarp will only fit one way"

Note: Do opposite corners, then sides and top with Part Number BB.
"Only corners on ends get double bungee"

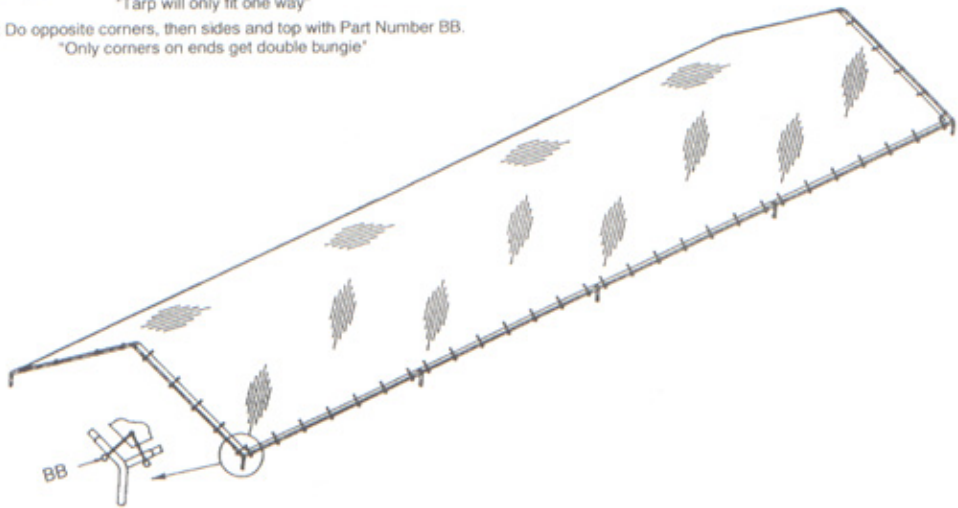

STEP 3: a) Insert Part Number P58HD into Part Number E3 and C4.
Start with one side and completing that side, then do the opposite side.

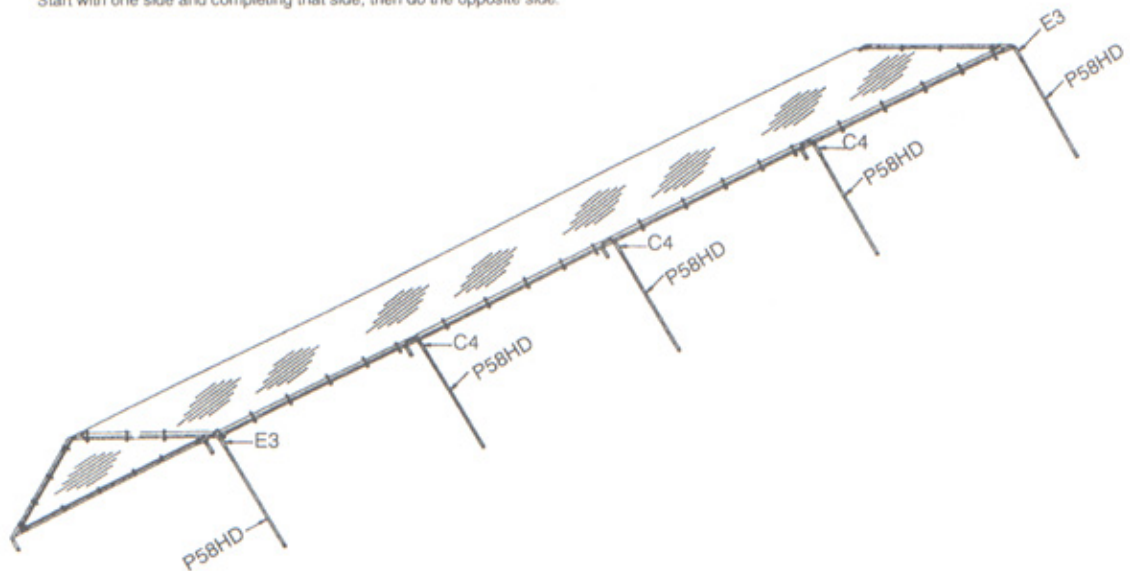

HELPFUL HINTS ON ASSEMBLY OF THE 18' x 40' CANOPY

1. Pick a good level spot to setup the All-Purpose Canopy.
2. If the tarp does not fit check the following:
 - a) Make sure poles are pushed firmly into all the 3-way end pieces and 4-way center pieces.
3. Remove tarp or take down canopy before (SNOW & WIND STORMS) this will keep the tarp and poles in good condition.
4. Make sure canopy is secured from the 3-way ends and 4-way centers down to the ground.
5. When putting legs on, start with the three center legs. The canopy will balance on those three legs, and complete that side. Do the same for the other side.
6. Enjoy!!

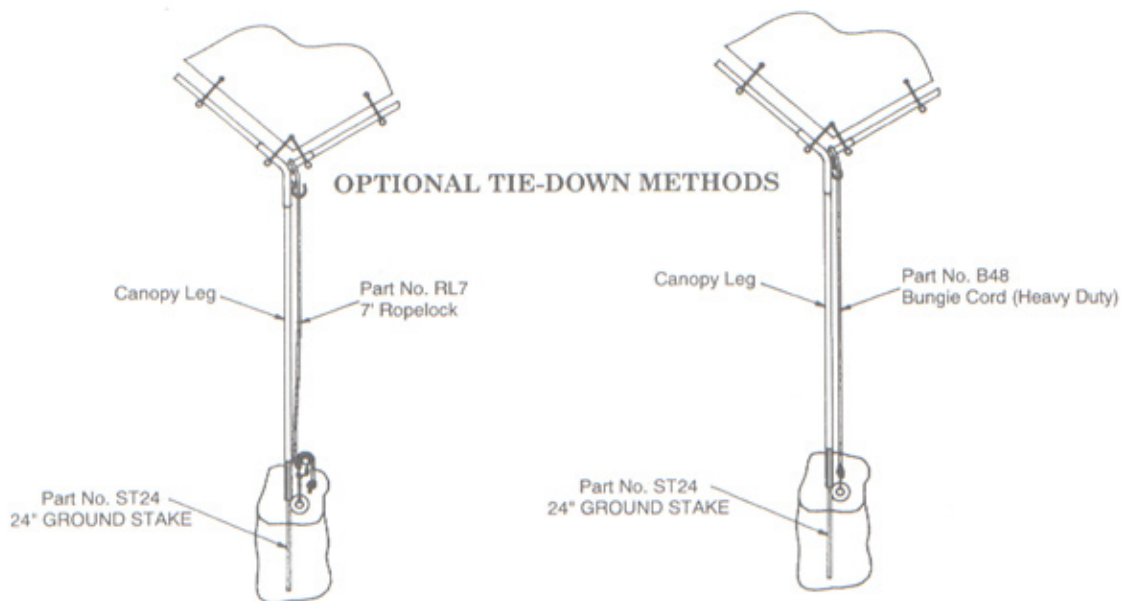

ALL PURPOSE CANOPY THIRTY DAY LIMITED WARRANTY

Harpster of Philipsburg promises to repair or replace the All Purpose Canopy or any part of it within thirty (30) days of purchase if defective in materials or workmanship. This limited warranty does not cover damage due to neglect, wind, snow, fire, misuse or any act of God, nor does this limited warranty cover damage resulting from the canopy not having been securely fastened down nor from improper installation. Harpster of Philipsburg makes no other warranty and the remedy of repair or replacement is the exclusive remedy. Harpster of Philipsburg, is not liable for indirect, incidental or consequential damages in connection with the use of the All Purpose Canopy, including any cost or expense of providing substitute equipment or service during periods of non-use. Any defective canopy or part must be sent, shipping pre-paid, to Harpster of Philipsburg, attention Warranty Department, 408 Airport Road, Philipsburg, Pennsylvania 16866.

EXCLUSION OF WARRANTIES

Harpster of Philipsburg makes no warranties which extend beyond the description on the face hereof. Specifically, the Warranty of Merchantability and the Warranty of Fitness for a Particular Purpose are Excluded. The only WARRANTY which is made by Harpster of Philipsburg is the 'THIRTY DAY LIMITED WARRANTY' described above.

www.harpster-canopies.com

Harpster of Philipsburg, Inc. • P.O. Box 429 • 408 Airport Road • Philipsburg, PA 16866 Phone: (814) 342-2930 • Fax (814) 342-4193 • Email: sales@harpster-canopies.com