

Rain Collector II

Installation manual

This instruction manual takes you step-by-step through the procedures required to install the Rain Collector II. The Rain Collector II is designed for use with any of Davis' weather stations (with the exception of the Perception II® Station). Each station can display rainfall in either inches or millimeters. Instructions for displaying rainfall on the Weather Wizard III® and Weather Monitor II® are also included in this manual.

Components

The Rain Collector II includes the following components. Please make sure you have all listed components before continuing.

- Rain Collector with Cable — The rain collector comes with the cone attached to the base and has a 40' (12m) cable.
 - Four #8 x 3/4" Screws
 - Debris Screen — This screen is placed into the rain collector cone to help prevent debris from clogging the funnel hole.
 - Metric Rain Adapter — This adapter adds weight to the tipping mechanism, adjusting it to tip for every 0.2 mm of rainfall instead of every 0.01".
-

Rain Collector Internal Components

The illustration below shows the internal components of the rain collector, many of which are referenced in this manual.

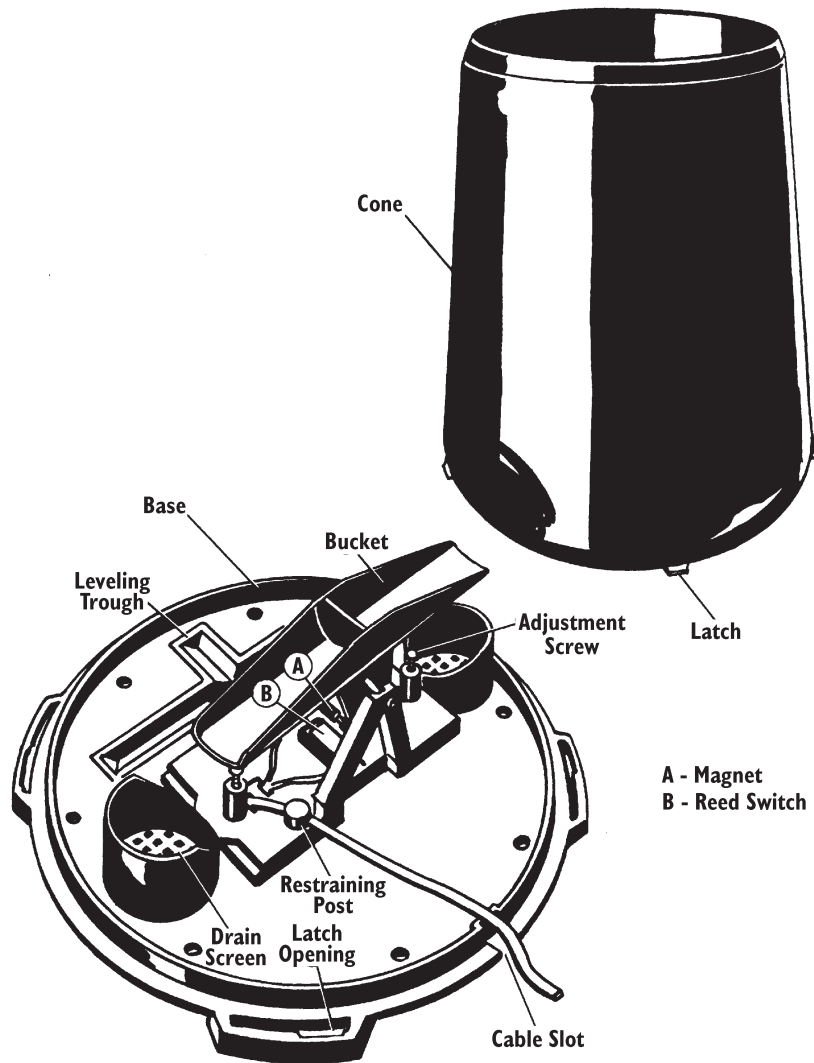

Rain Collector Internal Components

Tools and Materials Needed

You may need some of the following tools and materials to install the rain collector.

- Drill with 3/32" (2 mm) drill bit
- Medium Phillips Screwdriver
- 3/16" (or 5 mm) Wrench
- Cable Clips or Weather-Resistant Cable Ties with screw holes or other means for mounting
- Bubble Level (standard versions only)

Insert the Optional Metric Measurement Adapter

The rain collector tipping bucket mechanism contains a standard measurement weight magnet that takes measurements in .01" for every tip of the bucket. The Weather Monitor II assembly contains a metric measurement that adjusts the tipping bucket mechanism so that it takes .2 mm metric measurements. To change the weight magnet:

1. Find the metric measurement adapter included in the hardware.
2. Locate the standard measurement weight magnet between the arms of the tipping mechanism.
3. Open the arms slightly with one hand while pulling the magnet out with the other hand.

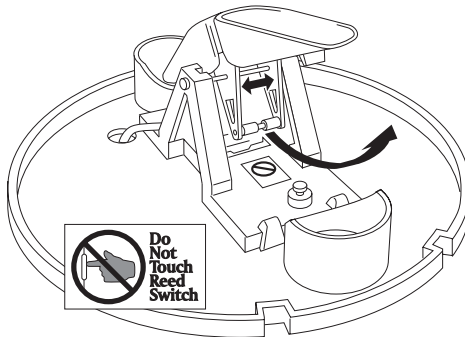

Open plastic tipping mechanism arms, pull out magnet

4. Separate an end cap from one side of the magnet.

-
5. Slide the magnet, with the exposed end of the magnet first, into the open slot of the metric measurement adapter.

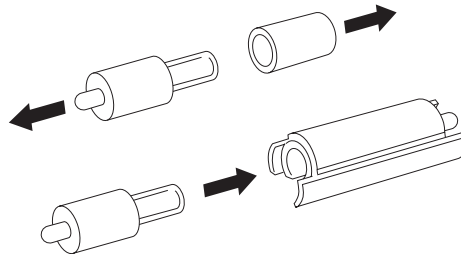

*Separate magnet from one end cap
Insert magnet with other end cap into metric measurement
adapter*

6. Insert the metric measurement adapter between the arms of the tipping bucket, with solid side of the metric measurement facing up.

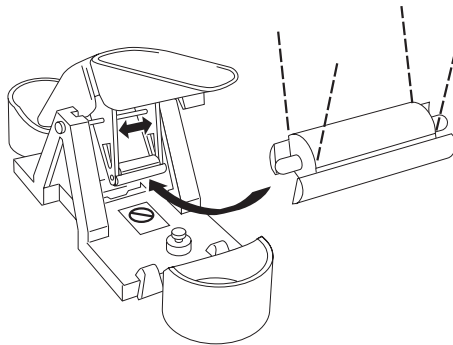

*Open plastic arms to insert metric measurement adapter,
with adapter in "V" position*

Although the rain collector is now ready to take accurate metric measurements, the console does not register the rain collector measurement weight has changed. The rain measurement type must be changed on the console.

Rainfall Calibration Number

Each station uses a rainfall calibration number (CAL) to determine how much water each bucket tip (i.e., pulse) represents.

$$\text{Calibrated Rainfall} = \text{Number of pulses} \times (1/\text{CAL})$$

The default rainfall CAL of 100 works for the 0.01" rain collector. If you have a 0.01" rain collector you do not need to adjust CAL at all.

If you install the metric adapter to your rain collector, first adjust the console to display rainfall in millimeters and then change CAL to 0005. (To change CAL, press and hold the RAIN button until CAL appears on the display. Consult the station manual, if necessary, for further instructions.) Be aware that the console will revert to its default calibration (i.e., inches) if it loses power.

Note: Make sure you display rainfall in the appropriate units of measure before changing CAL; otherwise you will be setting the wrong calibration number. If, by mistake, you change CAL before switching to the appropriate units, you can rectify the error by switching to the appropriate units and then entering the appropriate CAL (for millimeters, 0005; for inches, 0100).

Once the console is calibrated for 0.01" (default) or 0.2 mm, you can switch the display units as often as you like; the console accurately converts rainfall amounts regardless of the type of rain collector you use.

Caution to Pre-1994 Station Owners

If you purchased a Monitor or Wizard station prior to 1994, it may be pre-calibrated for an earlier model rain collector. See "Calibration of Older Model Weather Stations" on page 9 for instructions.

Testing the Rain Collector II

Before installing the Rain Collector II, test the unit. If you are replacing a rain collector you previously installed, make a note of the total rainfall amount displayed. You may want to reenter this amount after you test the rain collector.

1. Turn the rain collector upside down and remove the cone from the base by rotating the base until the latches on the cone line up with the latch openings in the base then lifting the base away from the cone.
2. Carefully cut and remove the plastic tie which holds the bucket in place during shipping.
3. Attach the rain collector cable to the appropriate connector on the junction box.
4. Consult your station manual or system installation manual.
5. Press the appropriate key on your console as necessary to display daily rainfall.
6. Press UNITS if necessary to display rainfall in the rain collector's native unit of measure.
7. While watching the display on your console to see if it changes, slowly tip the bucket until it drops to the opposite side. If the display does not change, you may be tipping the bucket too quickly. Try again, more slowly this time.

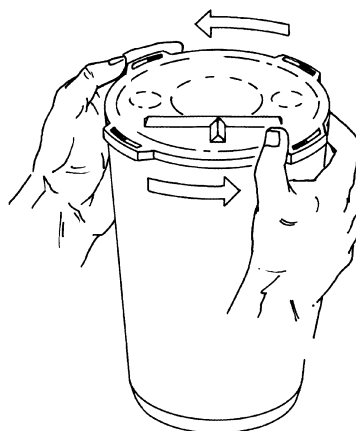

Remove the Cone from the Base

If the rainfall amount displayed on the console increases by the expected increment (either 0.01" or 0.2 mm) each time you tip the bucket, your rain collector is working properly. If the display changes only after you tip the bucket several times, the rain collector may be functioning correctly but you may have an older version of the station console. See "Calibration of Older Model Weather Stations" on page 14 for details.

Installing the Rain Collector II

Note: Climbing on your roof may be hazardous. If you are uneasy about installing your unit please have a qualified professional complete the installation. Davis specifically disclaims any liability for injury or loss resulting from the installation or use of the Rain Collector II.

Follow the instructions in this section to install your rain collector. Make sure you read "Choosing a Location for the Rain Collector" on page 5 as it contains important information concerning placement of the rain collector.

Typical Weather Monitor II Installation

The illustration below shows a typical rain collector installation for the Weather Wizard III and Weather Monitor II.

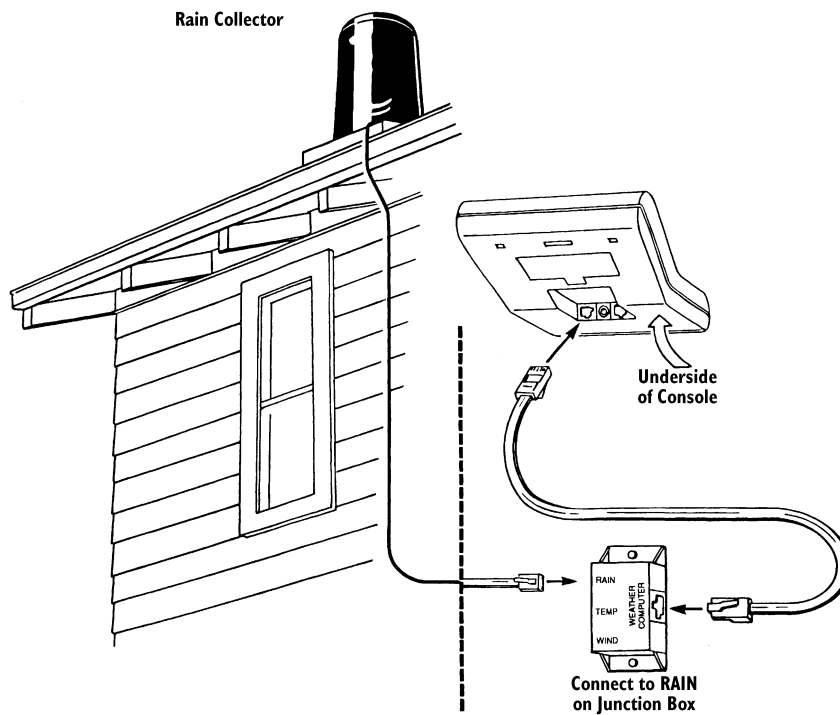

Typical Installation

Choosing a Location for the Rain Collector

Keep the following in mind when choosing a location for your rain collector:

- You must mount the Rain Collector II on a level surface. To make sure the surface is level, use a bubble level or pour water into the T-shaped leveling trough in the collector base and observe the surface of the water to ensure that the collector is level.
- Be sure there is an unobstructed path for water runoff from the drain screens.
- The Rain Collector II contains a magnet-operated switch which may not operate correctly if you mount the rain collector on or near any object which attracts a magnet.

To install the rain collector on a sheet metal roof, insulate the unit by making a platform out of wood. Mount the base of the rain collector at least 1" (4 cm) away from any steel or iron surface and make sure the reed switch is at least 1" (4 cm) away from any steel or iron objects (e.g., nails).

- Choose a location which is easily accessible for normal cleaning and is distant from trees or other sources of heavy pollen or debris.

Installing the Rain Collector II

1. If you have not already done so, separate the cone from the base.
2. If necessary, disconnect the rain collector cable from the junction box.
3. Locate a suitable mounting surface, using the guidelines above.
4. Place the base on the mounting surface and mark the location of the four holes (the base has eight to choose from) you will use to secure the base.
5. Make pilot holes using a 3/32" (2 mm) drill bit. You should make the pilot holes about 1/2" (12 mm) deep.
6. Fasten the base to the mounting surface using the #8 x 3/4" screws provided
7. Attach the rain collector cable to the appropriate connector on the junction box.
8. To be certain the rain collector is functioning properly after installation, retest the unit as described "Testing the Rain Collector II" on page 2.
9. Once you are sure the unit is functioning properly, place the cone back onto the base by putting the latches on the cone into the latch openings in the base and rotating the cone clockwise until the latches "lock" into place.

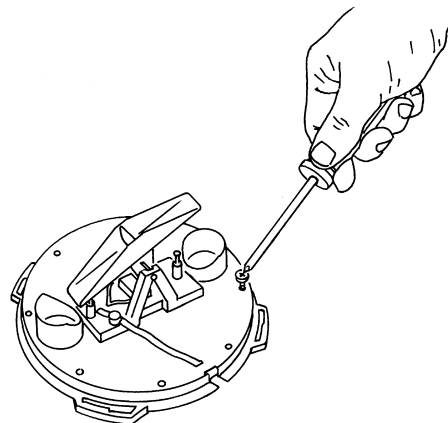

Fasten Base to Mounting Surface

Extending Cable Runs

As you reattach the cone, make sure to run the cable to the cable slot in the base, or the cone will not fit snugly against the base.

10. Place the debris screen, points down, into the cone. The screen prevents large bits of debris from blocking the funnel hole.

11. To prevent fraying or cutting of the cable where it is exposed to weather, it is important that you secure it so it doesn't whip about in the wind.

Use cable clips or weather resistant cable ties to secure the cable. Place clips or ties approximately every 3 to 5 feet (1 to 1.6 m). Do not use metal staples or a staple gun to secure cables. Metal staples—especially when installed with a staple gun—have a tendency to cut the cables.

Extending Cable Runs

If the cable length supplied with the rain collector is not long enough for your purposes, you may extend it. The maximum length of cable is 900 feet (270 m). Note that this length represents the total length from the rain collector to the console, including any length of cable from the junction box to the console. To extend the cable, purchase standard 4-Conductor Extension Cables from Davis and connect them to the existing rain collector cable.

Adjusting the Rain Collector II

The Rain Collector II is calibrated at the factory so the bucket tips (and records rainfall) for each 0.01" (or 0.2 mm if the metric adapter has been fitted) of rain. To adjust the calibration slightly, use a 3/16" (or 5 mm) wrench to rotate the adjustment screws which are located underneath the bucket (see "Rain Collector Internal Components" on page 2). The adjustment guide embossed in the platform shows how far you must rotate both screws in turn to effect a 1% and a 2% change. Moving the screws in the positive (+) direction causes the bucket to tip more times (i.e. give a larger count) for a given amount of water.

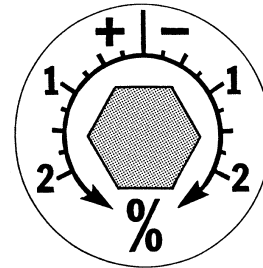

Adjustment Guide

Note: Modify both adjustment screws by the same amount.

To check the accuracy of the rain collector, compare the Davis Rain Collector with a tube type rain gauge. Use a rain gauge with an aperture of at least 4 inches. Any smaller and the readings obtained may not be accurate. Place the tube type rain gauge directly next to the Davis rain collector. Compare the totals on three storms. Based on this, develop an average for how far off the reading are. Adjust the screws to fine tune the reading for the next three storms if necessary.

Note: Do not compare rainfall readings to reading obtained from television, radio, newspapers, or neighbors readings. Such readings are not located in your specific environment and therefore are not an accurate measurement of the weather readings taking place in your surroundings. The rain collector is carefully tested at the factory to conform to the specifications listed in the back of this manual.

Maintaining the Rain Collector II

For greatest accuracy, you should thoroughly clean the Rain Collector II at least once or twice a year.

1. Disconnect the rain collector cable from the junction box.
2. Separate the cone from the base.
3. Use warm soapy water and a soft cloth to clean pollen, dirt, and other debris from the cone, cone screens, and bucket.
4. Use a pipe cleaner to clear the funnel hole in the cone and the drain screens in the base. When all parts are clean, rinse with clear water.
5. Reattach the cone and replace the screen.
6. Reconnect the rain collector cable to the junction box.

Using the Rainfall Function

The instructions below explain how to display rainfall on the Weather Wizard III and Weather Monitor II.

To Display Rainfall

1. To display daily rainfall, press RAIN. The daily rainfall and the word RAIN display.

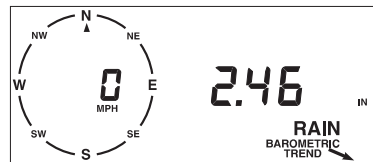

Daily Rainfall

2. To display total rainfall, press RAIN again. The total rainfall and the words RAIN and TOTAL appear on the display.

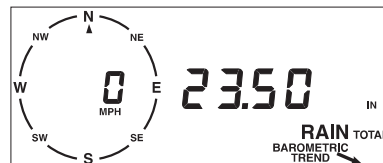

Total Rainfall

To Change the Unit of Measure

1. Press RAIN once or twice to select daily or total rainfall, as desired.
2. Press UNITS. The amount shown changes from inches to millimeters (or vice versa) and the symbol in the display changes from IN to MM (or vice versa).
3. To return to the original unit of measure, press UNITS again.

To Clear Rainfall

Daily and total rainfall are independent of each other. You must clear each register separately.

1. Press RAIN once or twice to select daily or total rainfall, as desired.
2. Press CLEAR and hold it down.

The display will flash several times and then the weather station clears rainfall.

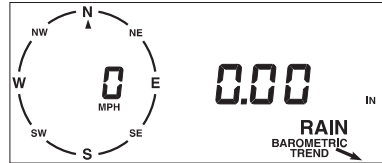

Daily Rainfall Cleared

Note: Performing a "total clear" on the weather station does not clear rainfall.

To Set Total Rainfall

You may enter a total rainfall amount to represent any rainfall which accumulated before you obtained the Rain Collector II:

1. Press RAIN once or twice to select total rainfall.
2. Use ENTER to set the total rainfall amount. See "Using the Enter Key" in the weather station manual.

Calibration of Older Model Weather Stations

This information applies only to users of the Weather Wizard II-S, Weather Wizard III, and Weather Monitor II manufactured prior to April, 1993. To check if your station meets this criterion, press the RAIN button on the console. If, when set to inches, the display reads 0.0 (rather than 0.00), you have an older model station.

Standard Setting

When using the 0.01" setting of the Rain Collector II with an older model station, note that the station is pre-calibrated for an earlier model 0.1" rain collector. To re-calibrate your station, first set the display to inches, then change CAL to 0100. (See "Rainfall Calibration Number" on page 2 and/or your station user's manual for instructions on how to change CAL.) Be aware that the console will revert to its default calibration (i.e., 0.1") if it loses power.

Metric Setting

When using the 0.2 mm setting of the Rain Collector II with an older model station, note that the station stores rainfall amounts in 0.2 mm increments but displays amounts rounded to the nearest whole millimeter.

Note: Keep in mind when testing the rain collector with older weather stations that the display adds 1 mm for each 5 tips of the bucket. Because the display rounds, however, the first change occurs after the bucket tips 3 times (0.6 mm rounded to 1 mm).

To calibrate your station for rounded millimeters, set the console to display rainfall in millimeters and then change CAL to 0005. (See “Rainfall Calibration Number” on page 2 and/or your station user’s manual for instructions on how to change CAL.) Be aware that the console will revert to its default calibration (i.e., 0.1”) if it loses power.

If you want your station to display rainfall in tenths of a millimeter, you can “trick” it into displaying in 0.2 mm increments. To “trick” the station, first display rainfall in *INCHES* and then enter a CAL value of 0005. To display rainfall thereafter, leave the unit of measure set to inches. Even though the display will show IN on the right hand side, the value will actually be in millimeters. Please note, however, that if you do employ this “trick” the maximum total rainfall will be 999.8 mm, rather than 9999 mm.

Troubleshooting Guide

Before calling Technical Support (1-510-732-7814), carefully check the following troubleshooting guide. You may be able to solve the problem yourself.

- Rainfall is not registering on the console or the console has a large error. Try the following:
 - Check the cable connections from the sensor to the console. Cable connections account for a large portion of the potential problems. Connections should be firmly seated in the jacks and plugged in straight. If you think a connection may be faulty, try jiggling the cable while looking at the display. If a reading appears intermittently on the display as you jiggle the cable, the connection is faulty.
 - Make sure there is no magnetic, steel, or iron object near the rain collector.
 - Make sure the funnel hole in the cone is clear so water can empty into the bucket.
 - Make sure the bucket moves freely when tipping to *both sides*. The console should show an increase in rainfall for each tip of the bucket. (If the bucket does not move at all, check that you have cut the cable tie that holds it in place during shipping.)
 - Make sure the console is calibrated correctly by setting the console to your unit preference *before* viewing or changing the CAL value (to 0100 for inches, to 0005 for millimeters). If this does not correct the problem, see “Calibration of Older Model Weather Stations” on page 14 to determine if your station is an older model station that warrants re-calibration.
 - The console will revert to its default calibration if it loses power. You will need to re-calibrate on power up if you have an older model station or a 0.2 mm rain collector.
- Rainfall amount shown on console has a small error.
 - Make sure the rain collector is mounted on a level surface. Use the adjustment screws (see “Adjusting the Rain Collector II” on page 11) to adjust the rain collector’s sensitivity, if necessary.
 - If you believe the rain collector to be installed and calibrated correctly and you still detect a small error, you can tweak the console’s calibration. Use the rainfall calibration equation on page 3 to adjust the calibration number. (Note: Tweaking will only work with the 0.01” rain collector; the calibration number for millimeters (5) is too small to be tweaked precisely.)

Contacting Davis Technical Support

If you have any questions, or encounter problems installing or operating your Vantage Pro2 weather station, please contact Davis Technical Support. We'll be glad to help.

(510) 732-7814 — Monday - Friday, 7:00 a.m. - 5:30 p.m. Pacific Time. Sorry, we are unable to accept collect calls.

(510) 670-0589 (fax)— Technical Support.

support@davisnet.com — E-mail to Technical Support.

info@davisnet.com — General e-mail.

www.davisnet.com — Davis Instruments web site. See the Weather Support section for copies of user manuals, product specifications, application notes, and information on software updates. Watch for FAQs and other updates.

Specifications

General

Sensor Type	Tipping bucket with magnetic reed switch
Output	Contact closure
Attached Cable Length	40' (12 m)
Cable Type	4-conductor, 26 AWG
Connector	Modular connector (RJ-11)
Recommended Maximum Cable Length	900' (270 m)
Housing Material	UV-stabilized ABS plastic
Dimensions	
Rain Collector	8.75" diameter x 9.5" high (16.5 cm diameter x 24 cm high)
Collection Area	33.2 in ² (214 cm ²)
Weight	2 lbs. 3 oz. (1 kg)

Console Data

These specifications apply to sensor output as converted by Davis Instruments weather station consoles.

Weather Monitor/Wizard Range

Daily Rainfall	0.00" to 99.99" (0.0 mm to 999.8 mm)
Total Rainfall	0.00" to 99.99" (0.0 mm to 9999 mm)

Accuracy

Rainfall	±4%, ±1 rainfall count between 0.01" and 2.00" per hour (0.2 mm and 50.0 mm per hour); ±5%, ±1 rainfall count between 2.00" and 4.00" per hour (50.0 mm and 100.0 mm per hour)
Resolution	0.01" (0.2 mm)
Sample and Display Update Interval	16 seconds (max)

WeatherLink® Data

These specifications apply to sensor output as logged and displayed by the WeatherLink.

Daily Rainfall	Total during archive interval
Total Rainfall	Total during archive interval
Rate of Rainfall	Maximum value during archive interval (For Vantage Pro and Pro2 models only)

Input/Output Connections

Black & Red	Switch terminal
Green & Yellow	Switch terminal

Notes

Product Number: 7852
Rain Collector II

Part Number: 07395.224
Rev B Manual (10/21/05)

This product complies with the essential protection requirements of the EC EMC Directive 89/336/EC.
Copyright © 2004 Davis Instruments Corp. All rights reserved.



3465 Diablo Avenue, Hayward, CA 94545-2778 U.S.A.
510-732-9229 • Fax: 510-732-9188
E-mail: info@davisnet.com • www.davisnet.com