

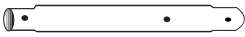

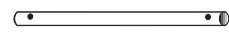

# CARPORT-IN-A-BOX Model #62656

Please read instructions completely before assembly

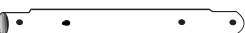

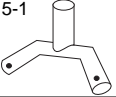
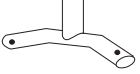
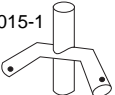
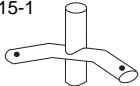
	Description	Part #	Qty.
RP 605012-1 	Swedged Rafter Poles 2" x 60"	10000-1	8
CR 773410-1 	Cross Rails no swedge 1 3/8" x 77"	10002-1	15
CLUP 585012-1 	Swedged Corner Poles 2" x 58"	10003-1	4
UP 685012-1 	Swedged Middle Poles 2" x 68"	10004-1	4
CLB 215012-1 	Corner Leg Bends	10005-1	4
SB 35012015-1 	3-Way Side Corners Have a sharper bend	10006-1	4
TB 35013615-1 	3-Way Top Connectors Have a sloping bend	10007-1	2
SB 45012015-1 	4-Way Side Connectors Have a sharper bend	10008-1	4
TB 45012015-1 	4-Way Top Connectors Have a sloping bend	10009-1	2
C18X20FLP7GYW 	All-Weather Cover	10026-1	1
FP 35082D3H-1 	Foot Plates	10013-1	4

**ATTENTION:  
BOLTS ARE NOT  
NEEDED OR  
INCLUDED FOR  
EVERY CONNECTION  
BUT MAY BE  
PURCHASED BY  
CALLING THE  
NUMBER BELOW**

**FOR MISSING OR  
REPLACEMENT  
PARTS OR  
QUESTIONS  
PLEASE CONTACT**

**CUSTOMER SERVICE:  
1.203.931.4777**

12X20X8CPW2

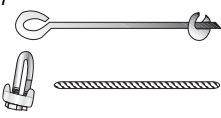

17 Wood Street  
West Haven,  
CT 06516

	Description	Part #	Qty.
847	 Temporary, 15" Auger Anchors cable - 1' lengths cable clamps	10014-0	4
		10015	4
		10016	4
	Bolts 2 1/2" x 1/4" (for feet, truss, corner legs)	10017	16 ea.
	Bolts 2" x 5/16" (for clamps)	10019	12 ea.
	Nuts 1/4" / Nuts 5/16"	10020 / 10120	16 / 12
705	Turnbuckles 5/16"	10021	4
4WCL5034-1	Half-Clamps for middle legs	10022-1	8
3WCL5034-1	Half-Clamps for corner legs	10023-1	8
RT 452810-1	Roof Trusses 1 1/8" x 45" (for middle 2 ribs)	10027-1	2

**ATTENTION:**  
**BOLTS ARE NOT NEEDED FOR EVERY CONNECTION BUT MAY BE PURCHASED BY CALLING THE NUMBER BELOW**

**FOR MISSING OR REPLACEMENT PARTS OR TO PLACE AN ORDER PLEASE CONTACT**

**CUSTOMER SERVICE:**  
**1.203.931.4777**

**YOUR INSTANT CARPORT IS PACKAGED WITH 15" TEMPORARY ANCHORS**

**!! ATTENTION !!**

**ALL-WEATHER ANCHORS RECOMMENDED**

**!! WARNING !!**

**FOR YEAR-ROUND, PERMANENT INSTALLATIONS**

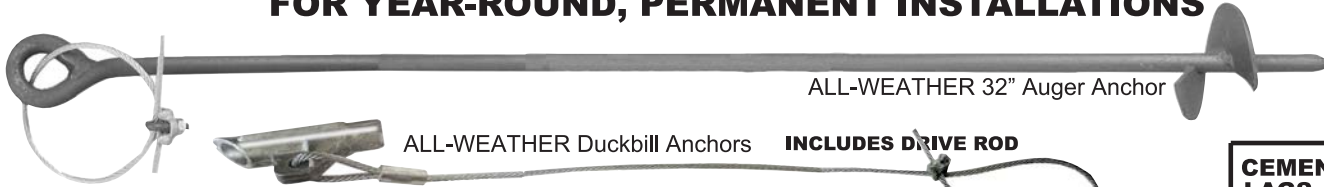

**AUGER ANCHORS 32" W / Hardware**  
 Dirt or Asphalt surfaces

Set of 6 .... Item # 10033-0..... ~~\$60.00~~ **\$39.99** \*S&H  
 Set of 8 .... Item # 10034-0..... ~~\$70.00~~ **\$49.99** \*S&H

**DUCKBILL ANCHORS INCLUDES DRIVE ROD**  
 Asphalt or Dirt surfaces

Set of 6 ... Item # 10035..... ~~\$60.00~~ **\$39.99** \*S&H  
 Set of 8 ... Item # 10036..... ~~\$70.00~~ **\$49.99** \*S&H

**CEMENT LAGS**  
~~\$45.00~~  
**\$29.99**.....  
 1200 lb. holding power  
 Item # 10032  
 Includes: 16 Lags, hardware



**CALL NOW TO ORDER ACCESSORIES & ANCHORS 1-800-524-9970**



**These heavy-duty anchors have withstood winds of up to 100 mph. Holding power in normal soil is 9600 lb using 8 anchors. (1200lb ea.)**

**CARE & CLEANING INFORMATION**

**DO NOT** expose top or walls to open fire or flame. **DO NOT** use barbeque grills or smokers underneath shelter. **DO NOT** use harsh abrasives, bleach or cleansers. Cover and walls can be easily cleaned with mild soap and water. Periodically check stakes or anchors to ensure stability of unit, especially following exposure to high winds or heavy rain. **NOT** meant to hold snow load, brush snow off top with a broom or mop.

**IMPORTANT: PLEASE READ CAREFULLY:** North American Outdoor Products has no control over the elements such as wind, snow or heavy rain, we cannot be responsible for damage caused by the shelter or to the shelter. We suggest you contact your insurance carrier for information just as you would for any other outside structure.

**Proper Anchoring is your responsibility. 15" temporary anchors are provided with shelter, we recommend 32" All-weather Anchors for Permanent Installations.**

**Improper Anchoring, Strong Winds, Snow or Ice.** North American Outdoor Products **does not guarantee these canopies in snow or ice under any circumstances.** Shelters are designed to offer protection from damage caused by sun, light rain, tree sap, & birds, and are not designed to hold the loads that accompany snow or ice. Any shelter that is not anchored securely or properly will fly away. We will not be responsible for any shelter that blows away. Proper anchoring is your responsibility. We offer several anchoring kits, call customer service for more information or to place an order.

# 1. FRAME ASSEMBLY

Assembly is easiest if you layout all parts as shown.

- Eight 2" x 60" (#10000-1) Rafter Poles, are swedged on both ends, and have 3 pre-drilled holes. Keep the middle pre-drilled hole toward the peak of the roof, this will allow you to install the 2 trusses on the middle 2 ribs, for snow & wind. (extra ones sold seperately)
- 1 3/8" x 77" (#10002-1) Cross Rails are not swedged, but have pre-drilled holes at each end, you will need nine cross rails for this step.
- You can set aside the Four, 2" x 68" (#10004-1) Middle Leg Poles, swedged on one end.
- and Four 2" x 58" (#10003-1) Corner Leg Poles, swedged both ends, 4 pre-drilled holes.
- It is very important that you determine which of the 3 & 4 way connectors are meant for the sides and which are for the top. The side connectors have a sharper bend, the top connectors have less of a bend.

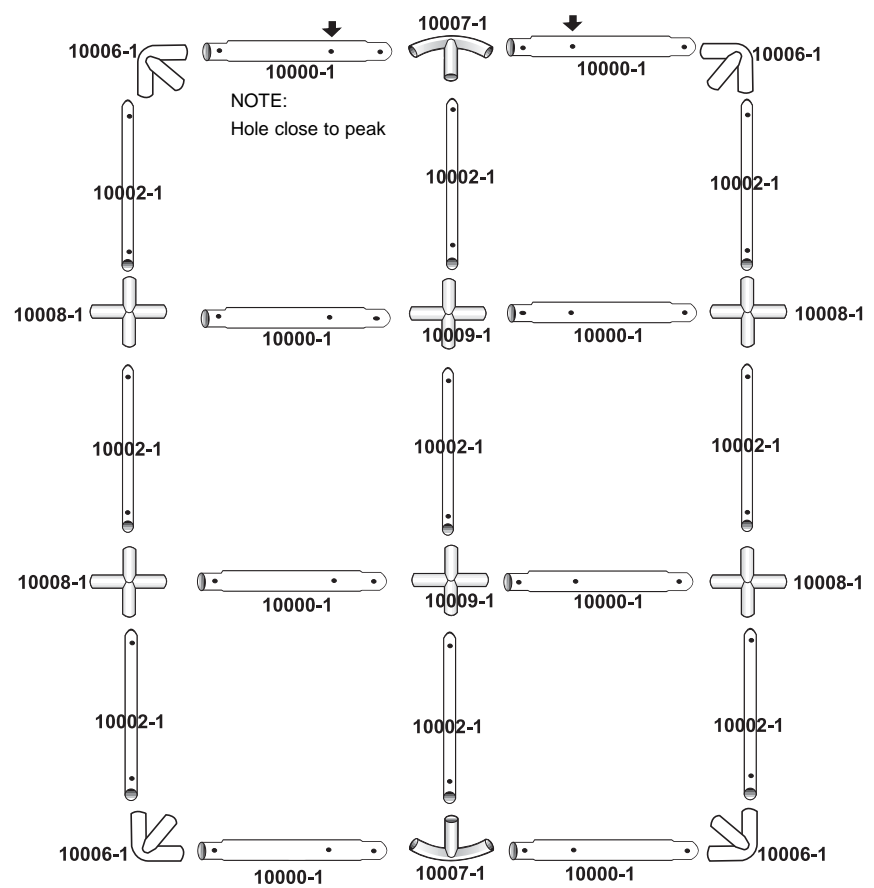
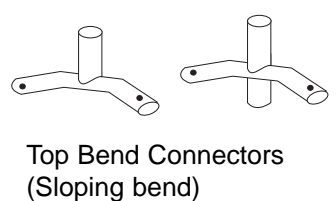
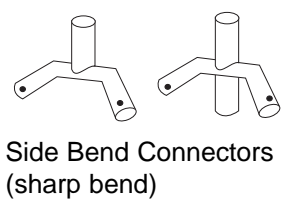

# 2. CONNECT PIPES & INSTALL TRUSSES

Start with the center, then assemble each side. Make sure the holes in the end of the rafter poles line up with the side bend connectors, and the center hole is towards the peak of the shelter. This will allow you to install the 2 trusses included. Once roof is assembled, install trusses on two middle sections, secure using 2 1/2" x 1/4" bolts & nuts.

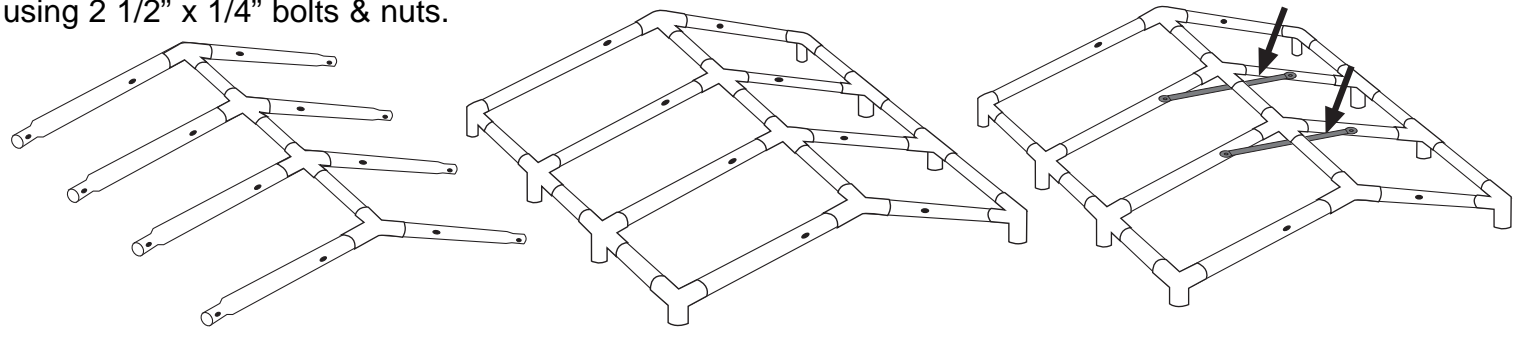

QUESTIONS WITH ASSEMBLY? OR TO ORDER ANCHORS: CALL CUSTOMER SERVICE 1-203-931-4777

### 3. ATTACHING LEGS

Assemble the 4 **Corner Leg Poles** as shown (10003-1 & 10005-1) and set aside for now. Then, Insert **Middle Leg Poles** ( 10004-1) on one side of the frame, swedged end up, then the **Corner Leg Poles** on that same side. Secure **corner legs (only)** to roof assembly with 2 1/2" x 1/4" bolt & nut. Repeat for the other side. Bolts are not needed for the middle legs, but holes are drilled if you want to purchase extra bolts. (1-203-931-4777 customer service).

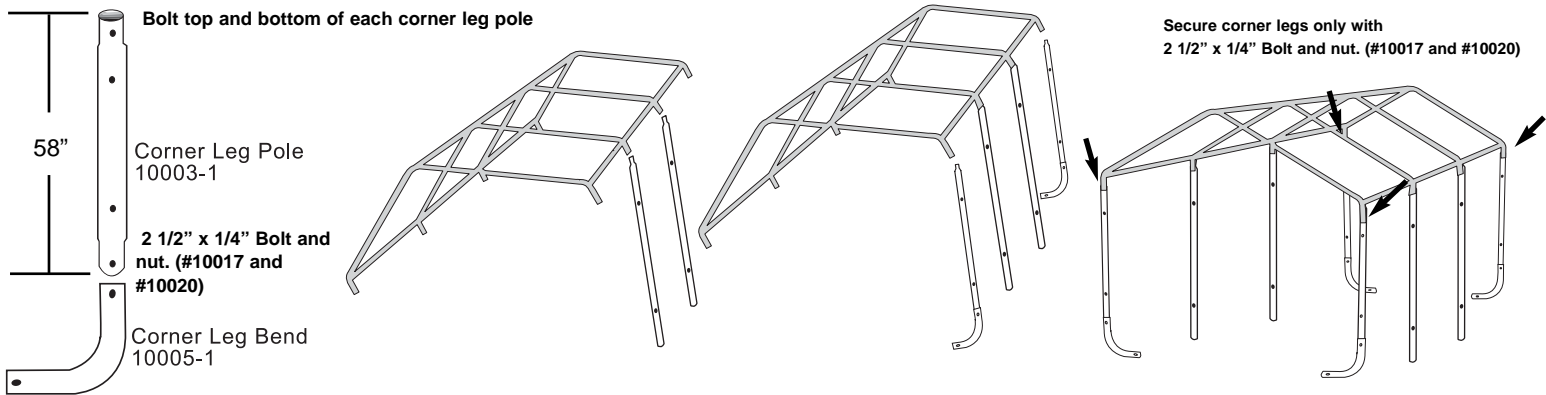

### 4. ATTACHING & SECURING BASE FEET

Depending on the model you have purchased, your base feet will either fit onto the **outside** of the leg poles, or slide **inside** the leg poles. After installing **Base Feet Plates onto** bottom of **Middle leg Poles**, be sure to line up the pre-drilled hole in the leg with the pre-drilled hole in the base foot. Insert 2-1/2" x 1/4" bolts all the way through leg and foot, to other side, secure with nuts.

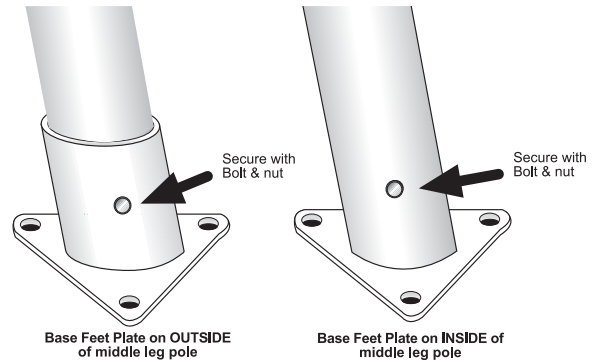

### 5. ANCHOR SHELTER

Place unit in final position, screw anchors into ground. You will secure the anchors to the corner leg bends using the cable and clamp. Be sure to put cable through the hole in the corner leg bend, and through eye of anchor, secure with clamp. Remember, these are **15" temporary (300 lb. hold) anchors**, We recommend 32" All-Weather anchors (1200 lb hold ea) for permanent installations.

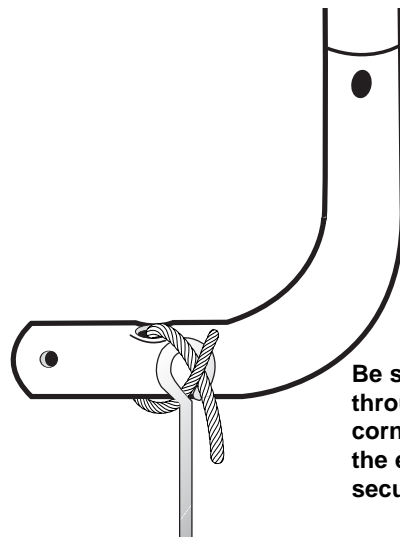
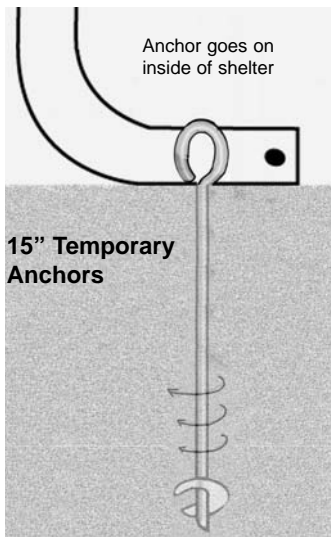

Be sure to run cable through the hole in the corner leg bend, through the eye of the anchor, and secure with clamp.

#### NOTE!

We recommend 32" All-Weather anchors (1200 lb hold ea) for permanent installations.

Your shelter is packaged with 15" temporary anchors (300 lb hold ea.)

Call customer service to order 32" All-weather, permanent anchors. 1-203-931-4777

## 6. ATTACHING COVER & CROSS RAILS

Pull cover over garage. The welded in ropes should be at the front and back of the building. Also note that the pocket at the base, running along the sides of the cover, should be on the inside. Loosen the 4 turnbuckles. Tie the ropes loosely to turnbuckles and check to be sure cover is still centered and has the same amount of overlap on the front and back, Pull ropes tighter, using a few knots to secure to turnbuckle. Then twist turnbuckles to tighten rope.

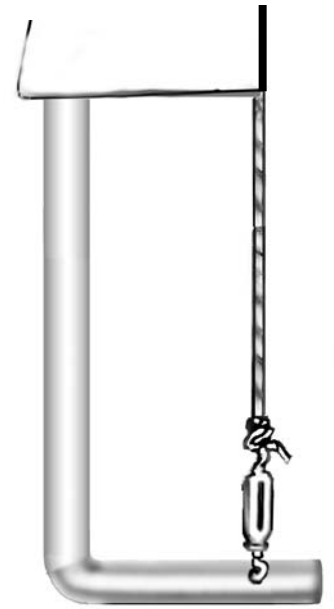
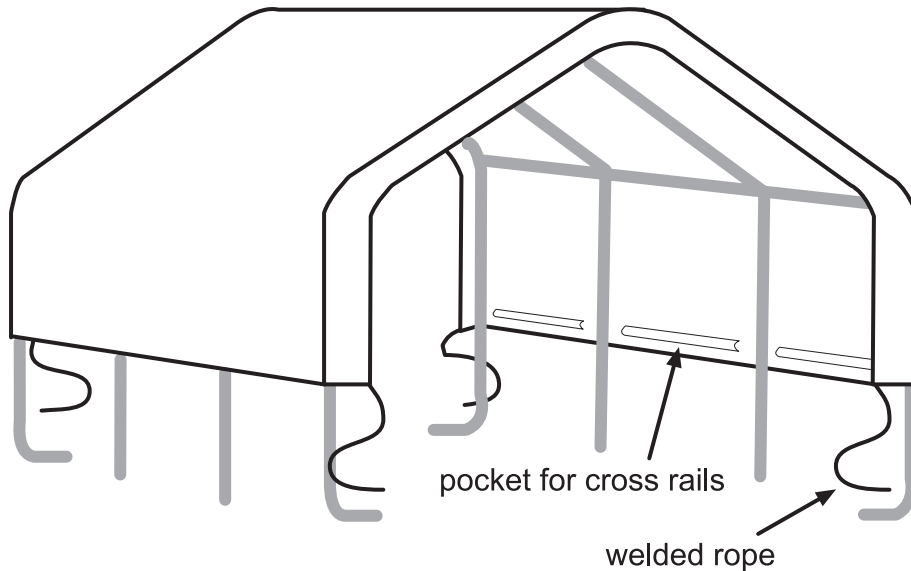

Now insert the leftover cross rails into the pockets, and secure the cross rails to the legs with clamps #10022 for the middle legs, and clamp #10023 for the corner legs. Use 2" x 5/16" bolts and nuts to secure. Bolt Through the Clamp, Cross Rail, and Clamp. Do not tighten down yet. Push down on cross rails to tighten cover before tightening bolts completely. Tightening bolts before pushing down on rails will scratch the powder coated finish.

The turnbuckles should be checked monthly to make sure the cover is tight.

### NOTE: BOLT THROUGH CLAMP, CROSS RAIL, CLAMP

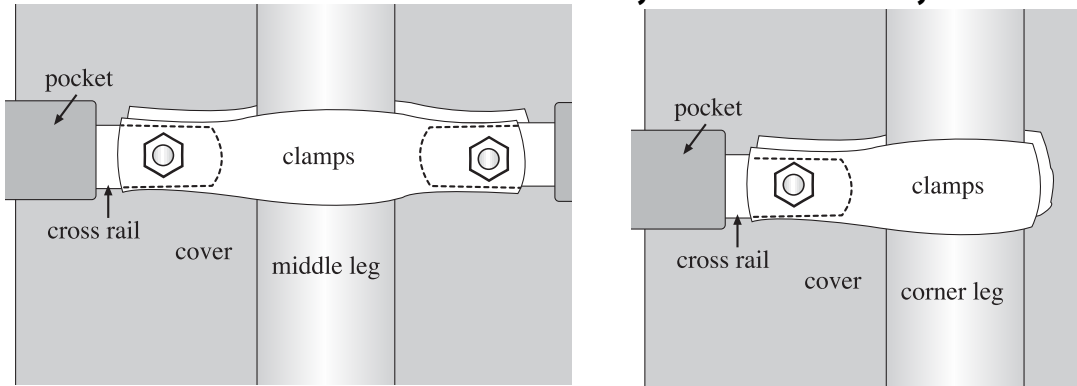

**IMPORTANT: If cover is installed and garage is not completed and left unattended, shelter must be tied down securely until completed. Call Customer sales for permanent anchors for dirt, cement, tar. 1-800-524-9970**

### CARE & CLEANING INFORMATION

**DO NOT** expose top or walls to open fire or flame. **DO NOT** use barbeque grills or smokers underneath shelter.

**DO NOT** use harsh abrasives, bleach or cleansers. Cover and walls can be easily cleaned with mild soap and water. Periodically check stakes or anchors to ensure stability of unit, especially following exposure to high winds or heavy rain. **NOT** meant to hold snow load, brush snow off top with a broom or mop.

**IMPORTANT: PLEASE READ CAREFULLY:** North American Outdoor Products has no control over the elements such as wind, snow or heavy rain, we cannot be responsible for damage caused by the shelter or to the shelter. We suggest you contact your insurance carrier for information just as you would for any other outside structure.

**Proper Anchoring is your responsibility. 15" temporary anchors are provided with shelter; we recommend 32" All-weather Anchors for Permanent Installations.**

**Improper Anchoring, Strong Winds, Snow or Ice.** North American Outdoor Products **does not guarantee these canopies in snow or ice under any circumstances.** Shelters are designed to offer protection from damage caused by sun, light rain, tree sap, & birds, and are not designed to hold the loads that accompany snow or ice. Any shelter that is not anchored securely or properly will fly away. We will not be responsible for any shelter that blows away. Proper anchoring is your responsibility. We offer several anchoring kits, call customer service for more information or to place an order.

QUESTIONS WITH ASSEMBLY? OR TO ORDER ANCHORS: CALL CUSTOMER SERVICE 1-203-931-4777