



PROGRESSION ST II



OWNER'S MANUAL

Issue 2 - December 14, 2000



ST II

OWNER'S MANUAL

TABLE OF CONTENTS

PAGE 1	WARRANTY
PAGE 2	FEATURES
PAGE 3	ASSEMBLY INSTRUCTIONS
PAGE 5	MOUNTING THE FRAME
PAGE 7	STRINGING THE FRAME
PAGE 10	PATHFINDER AWL
PAGE 11	MAINTENANCE AND ADJUSTMENTS
PAGE 14	TROUBLESHOOTING TIPS
PAGE 15	COMPONENT DRAWING
PAGE 16	COMPONENT LIST

LIMITED WARRANTY

GAMMA Sports (GAMMA) warrants to the original purchaser that the PROGRESSION stringing machine ("EQUIPMENT") purchased is free from defects in materials and workmanship for a period of five (5) years from the date of original purchase for mechanical parts (excluding electrical parts and string clamps), and for a period of one (1) year from the date of purchase for all electrical parts and string clamps. Should any defects develop under normal use within the specified time periods, GAMMA will at its option, repair or replace the defective EQUIPMENT provided it is returned to GAMMA prepaid at the purchaser's expense. This warranty does not apply to any damage or defect caused by negligence, abuse, misuse, unauthorized alteration, shipping, handling, or part wear and tear as a result of normal use.

GAMMA's obligation under this warranty is limited to repair or replacement of defective EQUIPMENT, and no one is authorized to promise any other liability. GAMMA shall in no event be liable for any incidental or consequential damages.

To return defective EQUIPMENT, a return authorization (RA#) must be obtained from a GAMMA customer service representative. The RA# must be marked on the outside of the shipping carton being returned. All returns must be shipped prepaid by the customer to GAMMA. Please retain the original shipping carton and packing materials for any future shipments. GAMMA will not be responsible for machines which are not sent in the original undamaged packaging.

FEATURES



Professional Six Point Quick Mount Racquet Mounting System - Accommodates All Racquets Without Adapters

Parallel Jaw String Gripper w/ Diamond Dust Coated Gripping Surfaces

Professional Quick Action, Diamond Dust Coated, Fixed String Clamps

Durable Polystyrene Base Cover w/ Convenient Padded Tool Tray

Strong, Light Weight, Powder Coated Molded Aluminum Construction

ASSEMBLY INSTRUCTIONS



Turntable Installation

Insert the center post of the turntable into the bushing of the stringing machine base.

Note: When purchased with the optional floor stand, it is most convenient to attach the base to the floor stand at this point. See instructions provided with the optional floor stand.

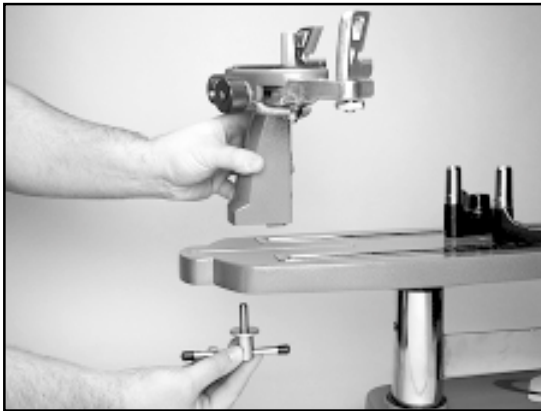

Frame Support Post Installation

The support post assemblies are precision aligned at the factory and are marked for proper installation on the turntable.

Install the marked support post on the marked side of the turntable. Align the threaded hole in the bottom of the support post with the slot in the turntable. Screw the lever lock bolt with washer into the bottom of the support post and tighten gently. Position the washer with the rounded edge toward the turntable.

Repeat procedure on the opposite side.

NOTE: 2 pcs. of M10 cap screws (#170) are provided with the machine in the event the lever lock bolts become inconvenient. Simply install the M10 screws in place of the lever lock bolts and tighten with the wrench provided.



Clamp Head Installation

The post of the string clamp head and tube of the string clamp base are treated with grease to provide protection against corrosion during shipping. Remove any excessive grease with a clean cloth prior to use. The post and tube may also be cleaned with isopropyl alcohol. After this type of thorough cleaning, the post and tube should be treated with a light coating of machine oil to protect the surfaces against corrosion and to ensure smooth operation.

ASSEMBLY INSTRUCTIONS



Installing the Tensioner

Remove the button head screw and washer located at the end of the tensioner bar with the 3 mm hex wrench provided. Slide the tensioner onto the bar, being careful to align the bar with all of the bearings and the drive gear with the gear track. Replace the screw and washer into the end of the tensioner bar.

Note: The tensioner bar is equipped with a tensioner travel stop to limit travel of the tensioner along the bar. See page 7 for more details about this feature.



Locking the Turntable

The turntable may be locked in any position.

The turntable winged lock knob is packed separately in the accessory polybag. Install the lock knob into the threaded hole located on the side of the tensioner bar post.

Rotate the knob clockwise to lock the turntable, and counter-clockwise to release the turntable.

MOUNTING THE FRAME



Adjusting the Frame Support Posts

Place the racquet frame over the center posts and onto the frame support. Loosen the lever lock bolt on one support post. Slide the post outward until the center support of the racquet support slide is positioned near the inside surface of the racquet frame. Securely tighten the lever lock bolt.

Adjust the opposite post using the same procedure.

Caution: To avoid racquet damage, the center posts should not contact the racquet prior to fixing the support posts.

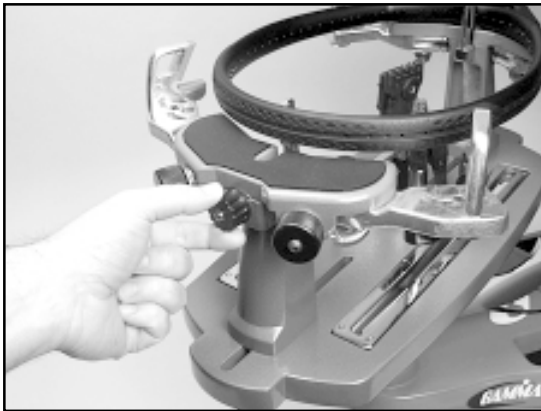

Tightening the Center Supports

Tighten the Frame Support Slides by turning the adjustment knob clockwise until slight resistance is felt.

Caution: Overtightening may cause racquet damage.

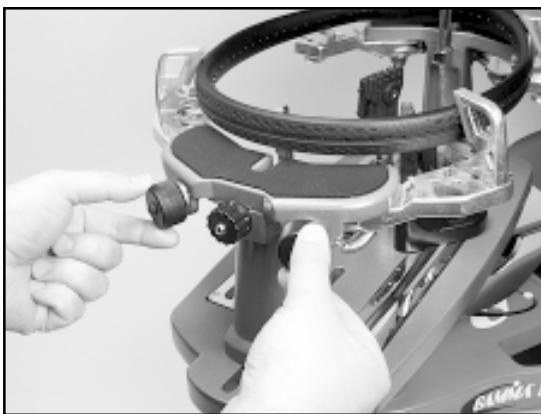

Frame Shoulder Support Adjustment

Being sure the shoulder supports are free to swivel in their mountings, simultaneously rotate the shoulder support adjustment knobs clockwise until both shoulder supports gently and squarely contact the frame.

MOUNTING THE FRAME



Securing the Frame Shoulder Clamps

Lock the shoulder supports in position by turning the knob at the base clockwise.

Repeat the adjustment procedure for the remaining support post.

Re-tighten all of the frame supports in the same order as before.

Do not overtighten any of the supports as racquet damage may occur.

The supports should be tightened to the point where the racquet frame will not move in the mounting system when the handle is grasped and attempts are made to move it. Should any supports lose contact with the frame while stringing, they should be re-tightened.

STRINGING THE FRAME

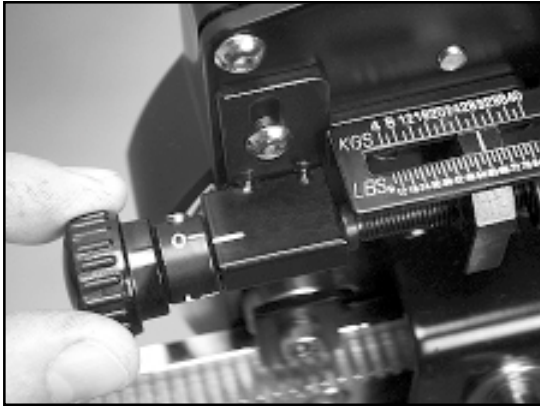

Setting Tension

The Progression STII utilizes a rotary adjusting knob along with a linear tension scale to indicate the tension setting. The scale is divided into 3 lb increments and each 1/3 turn of the tension knob changes tension by 1 lb. To set the desired tension, rotate the tension knob and align the mark on the spring guide with the desired tension setting on the scale. When the "0" mark on the knob aligns with the line on the knob support the tension will be that indicated on the scale. To increase tension by 1 or 2 lbs turn the knob counterclockwise until the "1" or "2" mark on the knob aligns with the line on the knob support. To decrease tension by 1 or 2 lbs, turn the knob clockwise until the "2" or "1" mark on the knob aligns with the line on the knob support.

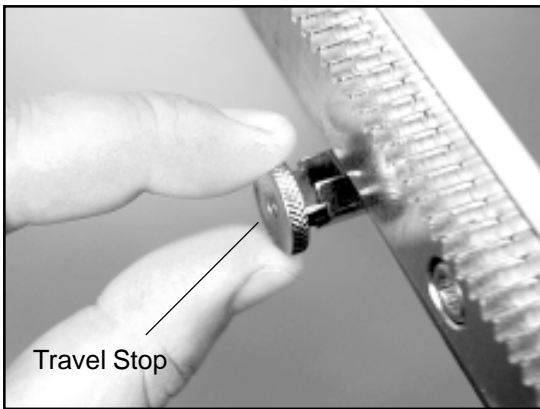

Tensioner Travel Stop

The tensioner bar is equipped with a tensioner travel stop to limit travel of the tensioner along the bar and prevent contact between the tensioner and the racquet mounting system while stringing. The travel stop is located about midpoint along the tensioner bar below the gear track.

To disengage the stop, pull and hold the knob, rotate 90 degrees and release. To engage the stop, repeat the above procedure until the travel stop pin protrudes beyond the opposite surface of the tensioner bar.



Clamp Head Operation

Quick Action Clamps are of a dual action design where as the clamp head and clamp base operate independently of one another.

To clamp a string, lift the clamp head and place the string between the jaws and depress the clamp head lever to secure the string. The clamping pressure applied to the string should be adjusted to provide sufficient pressure to secure the string when subjected to the desired pulling tension. The diamond coated gripper plates provide for increased friction between the clamps and the string to allow for reduced clamping pressure while securing and holding the string under tension.

Note: If the string slips in the string clamp while tensioning, adjust the gap between the clamp jaws per the instructions on page 13.

STRINGING THE FRAME

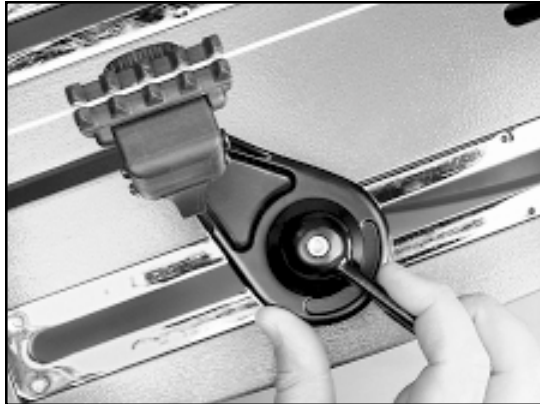

Clamp Base Operation

Rotate the Base Locking Lever clockwise to secure the clamp base to the turntable.

Reverse the clamping procedure to unlock the string clamp. The Locking Lever is spring loaded to assist the unlocking of the clamp base.

The Locking Lever should be tightened enough to prevent clamp base slippage on the turntable, when the desired tension is placed on the string. To go from the loose position to the clamped position and back, generally requires the rotation permitted by the slot in the clamp base. If the rotation is not sufficient to allow smooth operation of, adjust the Clamp Base Locking Nut as outlined on page 13.



Clamping the First Main String

To begin stringing the main strings, thread the two ends of the string through the two center holes at the appropriate end of the frame and continue through the opposite center holes. Thread one end of the string through the adjacent grommet hole and pull excess by hand.

Secure one of the strings using a string clamp.



Pulling Tension

Wrap the loose section of string once around the roller guide and insert the string between the diamond dust coated string gripper plates. Pull the string perpendicular to the gripper plates while slowly rotating the tensioner crank clockwise until the brake lever pops out of the latching block. The string is now tensioned and can be clamped in place with the remaining fixed clamp.

Repeat the above steps until all main strings are installed. Tie off ends of main strings as per racquet manufacturers recommendations.

STRINGING THE FRAME



Weaving the Cross Strings

Weave the cross strings over and under the main strings being careful to alternate the weave direction of each consecutive cross string so as to be opposite of the previously installed cross string.



Once the final cross string is tensioned and clamped, tie off at the appropriate hole specified by the racquet manufacturer.

PATHFINDER AWL



The Progression STII includes the new Pathfinder stringing awl which creates a pathway between and around strings to make inserting a string through tight grommets easier and quicker.

Insert the awl through the grommet hole in the same manner as for traditional awls. The Pathfinder awl must be in the closed position before insertion.



Once the awl is inserted, pull the handle of the awl outward while holding the tip section in place, leaving the outer sheath in the grommet hole. Insert the end of the string into the center of the sheath.

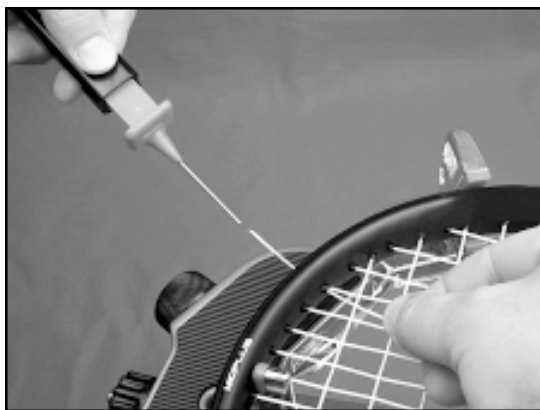

While holding pressure on the string, slowly pull the sheath out of the grommet hole to leave the end of the string exposed.

MAINTENANCE and ADJUSTMENTS



Tension Calibration Procedure

Step 1

Set the tension to 60 lbs. as indicated by the linear scale and rotary knob. Place the string on one end of a tension calibrator into a string clamp and secure. Place string located on the other end of the calibrator into the string tensioner and apply tension. If the brake lever releases before 60 lbs. or after 60 lbs., the tension head should be calibrated as follows.

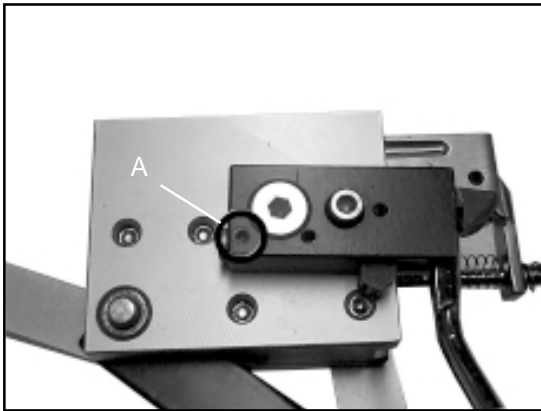

Step 2

Loosen the 1.5 mm locking set screw (A) located on the side of the latching block as shown. The set screw is used to hold the adjustment screw in place.

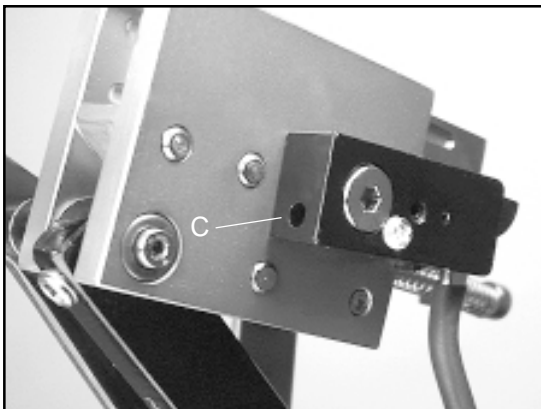

Step 3

If the lever releases before 60 lbs., using the supplied L-shaped hex wrench, turn the adjustment screw (C) located on the left side of the latch block counter-clockwise to increase the engagement of the brake release latch with the brake lever. Repeat step 1 and adjust until the correct tension is indicated on the calibrator.

If the tension indicated in step 1 is greater than 60 lbs., turn the adjustment screw clockwise to reduce the engagement of the brake release latch with the brake lever. Repeat step 1 and adjust until the correct tension is indicated on the calibrator.

MAINTENANCE and ADJUSTMENTS

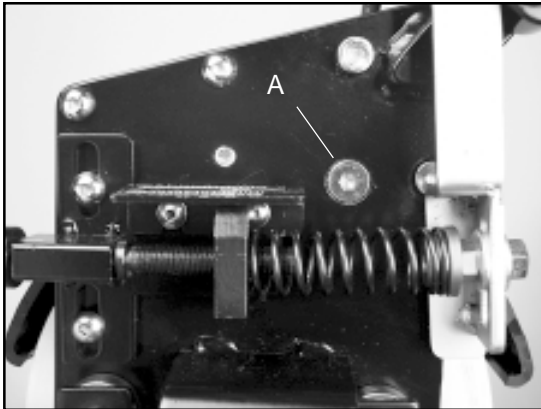

A - Lock Bolt

Adjusting the Tensioner Brake

Step 1

After stringing many racquets, the brake of the tensioner may need to be adjusted.

With the brake lever engaged, loosen the lock bolt located on the back side of the tensioner frame with the 4mm hex wrench.

Note: The lock bolt should only be loosened enough to be turned by hand and must not be removed completely.

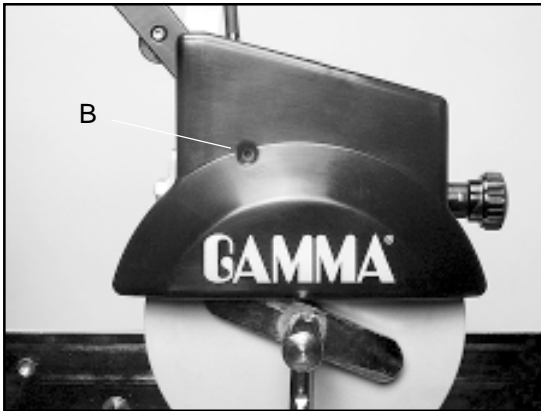

B - Brake Lever Adjustment Bolt

Adjusting the Tensioner Brake

Step 2

With the lock bolt loosened and the brake lever engaged in the latch, insert the 6 mm hex wrench through the hole in the tensioner cover and into the (B) brake lever adjusting bolt.

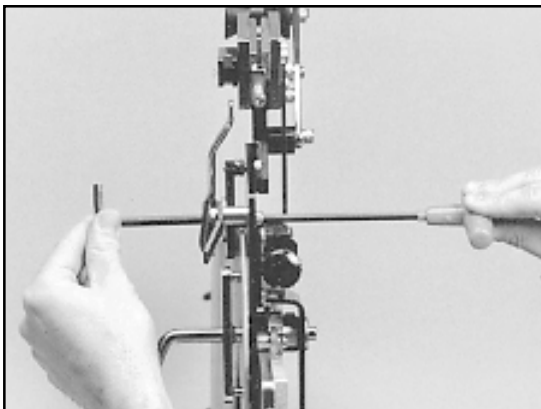

Adjusting the Tensioner Brake

Step 3

To tighten the braking mechanism, turn the brake lever adjusting bolt counter clockwise by about 1/8 turn. Retighten the lock bolt on the back side of the tensioner frame and check for brake tightness. The tensioner should move freely along the track with the brake lever engaged and should hold tension with the brake lever released. If more adjustment is needed, repeat steps above until properly adjusted.

Note: Cover Removed For Clarity

MAINTENANCE and ADJUSTMENTS

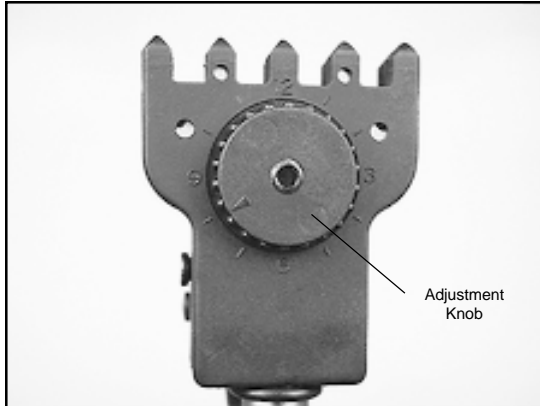

Adjusting the Clamp Jaws

The **Quick Action** Clamps will need minor adjustments according to what string type, construction, and gauge you are using.

To adjust the gap (clamping pressure) between the clamp jaws, insert the string through the racquet as if you were beginning the main strings. Clamp the strings and pull tension. If the string slips through the jaws of the clamp, tighten the clamp by compressing the clamp jaws together by hand while turning the Adjustment Knob, in the clockwise direction. If the clamp leaves impressions or damages the string, it may be excessively tight and should be adjusted by turning the hex screw counter clockwise to open the gap between the jaws. The clamp jaws should be cleaned periodically to be free from dirt, oil, and any string coating for them to grip properly.

Note: The string clamps supplied with your stringing machine can accommodate tight string patterns such as badminton. Depending on the string pattern, the clamp may spread the strings slightly which will not compromise the quality of the string job.



Clamp Base Locking Nut Adjustment

In the event the Locking Lever rotation is insufficient to ensure smooth operation of the clamp base, very minor adjustments to the Clamp Base Locking Nut can be made with the supplied 17mm wrench. Tighten or loosen the locking nut in very small increments to provide more clamping pressure or running clearance as needed.



Turntable Bushing Adjustment

The Progression STII is adjusted at the factory for optimum performance. After time and use, the turntable bushings may need minor adjustment. An adjustment is indicated when noticeable turntable looseness or wobble occurs while stringing.

To adjust the fit between the turntable pin and the bushings, tighten the set screws located on the back side of the tensioner bar post using a 3mm hex wrench. Tighten until the turntable rotates smoothly without excessive free play.

TROUBLESHOOTING TIPS

PROBLEM	SOLUTION
String slips in clamps	<ul style="list-style-type: none">- Adjust gap between jaws- Clean clamp jaws
String slips in gripper.	<ul style="list-style-type: none">- Clean gripper jaws.- Adjust Gripper Jaw Stop Screw
String clamp base slips on turntable.	<ul style="list-style-type: none">- Adjust Clamp Base Locking Nut.- Clean Turntable Clamp Glide Rails
Tensioner slips on Tensioner Bar after brake lever is released.	<ul style="list-style-type: none">- Adjust tensioner brake lever- Clean tensioner brake disc
String tension too tight or too loose	<ul style="list-style-type: none">- Check tension using a tension calibrator and adjust machine calibration if necessary

For additional assistance, contact Customer Service

CARE and CLEANING

With time and use, the clamping surfaces of your machine may become oily or dirty and result in string or clamp slippage while stringing. Periodic cleaning of the following parts is recommended.

String Clamps

Clean the inside gripping surfaces of the string clamp jaws by inserting a cloth or pipe cleaner soaked with isopropyl alcohol between the jaws and rub back and forth. If the build-up is excessive, dismantle the string clamp jaws to expose the gripping surfaces by removing the adjustment knob. Using a small nylon brush, (such as a toothbrush), scrub the inside surfaces until all debris is removed. Clean the jaws with isopropyl alcohol and re-assemble.

String Clamp Base

Clean the base of the clamps and the top of the turntable with isopropyl alcohol.

String Gripper

Clean inner gripping surfaces with isopropyl alcohol soaked cloth or pipe cleaner.

EXPLODED PARTS VIEW

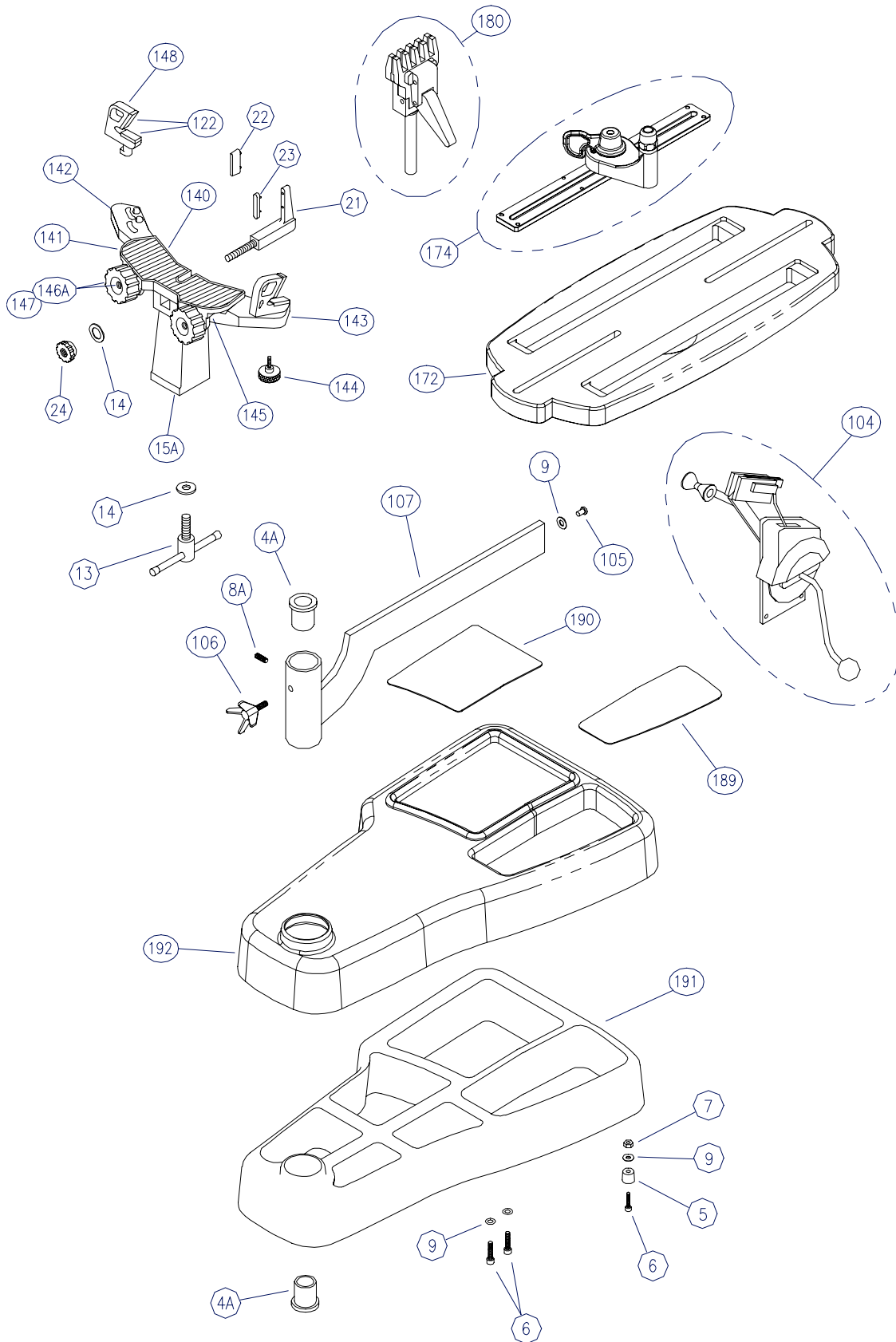

PARTS LIST

PART #	DESCRIPTION	PART #	DESCRIPTION
4A	TURNTABLE BUSHING	145	ARM RETURN SPRING
5	RUBBER FEET	146A	ARM ADJUSTMENT KNOB
6	CAP SCREW	147	ARM ADJUSTMENT SCREW
7	FOOT NUT	148	SHOULDER V-CLAMP
8A	BUSHING SET SCREW	172	2020-25 TURNTABLE
9	WASHER - M8	174	QA CLAMP w/GLIDE BAR
13	POST LOCK LEVER	180	COMP. FIXED CLAMP (THIN)
14	WASHER - M10	189	P11 LOWER TRAY PAD
15A	2021 SUPPORT POST	190	P11 UPPER TRAY PAD
21	FRAME SUPPORT SLIDE	191	P11 ST ALUMINUM BASE
22	BADMINTON ADAPTER	192	P11 ST PS BASE COVER
23	TENNIS ADAPTER		
24	SUPPORT SLIDE KNOB		
104	TENSIONER ASSEMBLY		
105	RETAINER SCREW	70	HEX WRENCH - 5MM
106	TABLE BRAKE KNOB	72	PATHFINDER AWL
107	TENSIONER BAR	73	STRINGERS AWL
122	SHOULDER PADS (RED)	98	BOX WRENCH - 10MM
140	MTNG. STAND TOP PLATE	108	UTILITY KNIFE
141	MTNG. STAND PAD	109	NEEDLE NOSE PLIERS
142	SUPPORT ARM - LEFT	167	10 PC. HEX WRENCH SET
143	SUPPORT ARM - RIGHT	170	M10 SUPP - POST SCREWS
144	SUPPORT LOCK KNOB	196	BOX WRENCH - 17MM
			TOOLS AND ACCESSORIES