









Rectangle Pot Rack Installation Instructions

Thank you for purchasing the Rogar International Rectangle Pot Rack. Installation of the Pot Rack is quick and easy, requiring only routine hand tools.

1. Parts List

Compare the parts in the carton to the parts list below. Check each part for damage. If any part is missing or damaged, call Rogar International for replacement instructions.

Quantity	Part Name
1	Assembled Rectangle Pot Rack Frame
4	Button Head Hex Socket Screws ($\frac{1}{4}$ " x $1\frac{1}{4}$ "
4	Ceiling Hooks 
8	Center Pot Hooks 
1	Grid 
4	Hanging Brackets 
1	Hex Head Key (Allen Wrench)
4	Plastic Screw Covers
4	"S" Chain Hooks 
4	"S" Pot Hooks 
4	24 Inch Chains

2. Tools Required

Drill
Pencil
Pliers
Ruler

A method of locating the ceiling joists is required. An electronic, sonic, or magnetic stud finder is best, though other means may be utilized.

3. Planning the Installation

CAUTION: The Pot Rack must be attached directly to structural framing members. Mounting to wallboard, plaster, etc., even if using toggle bolts, is not adequate.

The Rectangle PotRack, when loaded with utensils, is quite heavy. Therefore, the supplied ceiling hooks must be attached directly to the ceiling joists or other structural framing member. When deciding where to hang the Pot Rack, access to the ceiling joists must be considered. The exact location of the ceiling hooks is determined by the location and direction of the ceiling joists.

4. Ceiling Hook Installation

Refer to Figure 1. Locate the ceiling joists and mark the locations for the ceiling hook installation. The ceiling hooks should be spaced lengthwise along the Pot Rack 16 to 24 inches apart. The ceiling hooks at each end of the Pot Rack should also be spaced 16 to 24 inches apart.

Drill four holes using a drill bit somewhat smaller than the smooth shank of ceiling hook. Make sure the bit drills into the ceiling joist; if it drills into an open area, search again for the ceiling joist, and drill a new hole.

Screw a ceiling hook into each hole $\frac{1}{2}$ past the point the threads are no longer visible, or until the threads are entirely into the ceiling joist. Turn the ceiling hook so the open end of the hook points outward from the rectangle formed by the four hooks, as shown in Figure 3. This reduces the chance of the chains slipping off the hooks.

5. Assembling the Grid to the Rectangle Pot Rack

Refer to Figure 2. The hanging brackets attach to the long side rails of the Pot Rack. Note the holes drilled in the side rail are not centered vertically. Set the Pot Rack so the holes are closer to the **top** edge. Attach two hanging brackets to one of the side rails using two button head hex socket screws, arranging the hanging bracket so the rounded end with the hole is above the top edge of the side rail. Attach the remaining hanging brackets to the other side rail, but only start the screws into the holes. Do not tighten. Set the grid in place, resting it on top of the horizontal tabs of the hanging brackets, and under the two tightened screws. Tighten the remaining two hanging bracket screws. Install a plastic screw cover over the threads of each of the four screws.

6. Hanging the Rectangle Pot Rack

Refer to Figure 3. Install a small "S" hook onto each of the hanging brackets on the Pot Rack, with the open end of the hook facing outward. Connect a chain to the open end of each "S" hook. Hook the opposite ends of the chains to the ceiling hooks. The chains may be shortened to hang the Pot Rack closer to the ceiling or to accommodate sloped ceilings. Extra chain is available from Rogar International.

7. Pot Hook Installation

The eight center pot hooks hook over the side rails of the Rectangle Pot Rack wherever desired. The four "S" pot hooks hook onto the grid wherever desired.

The Rectangle Pot Rack installation is now complete.

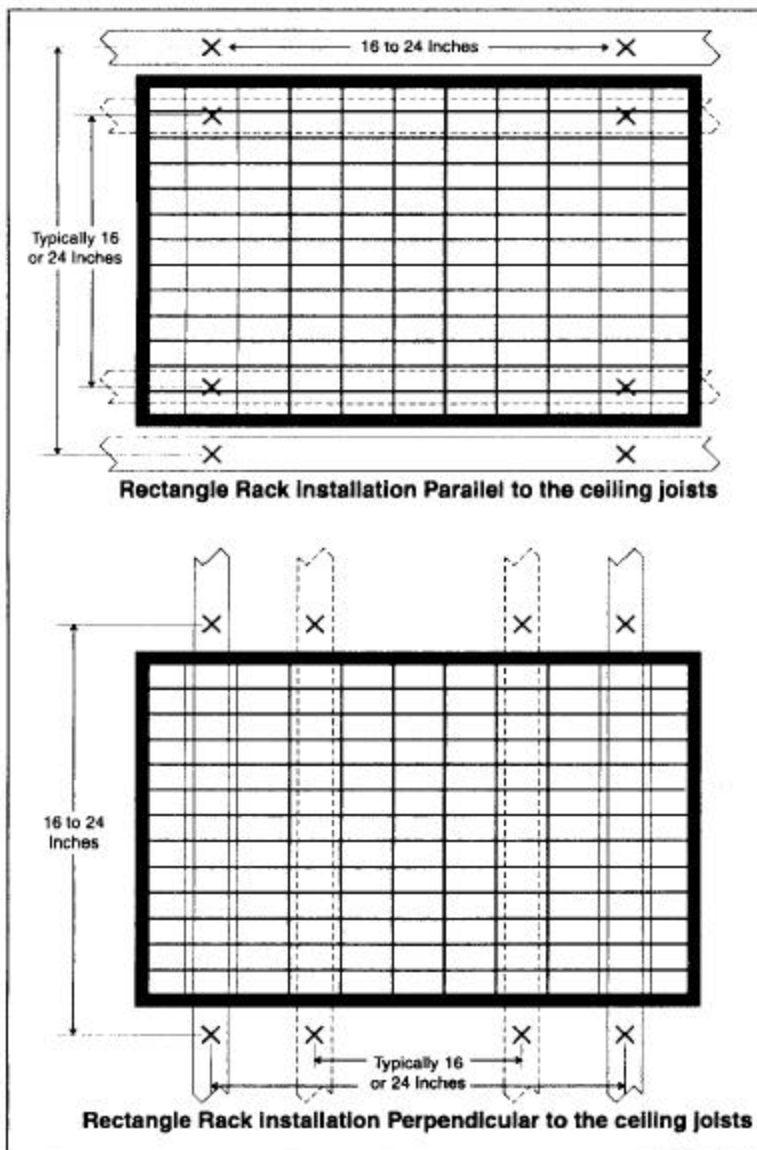

Figure 1
 Ceiling Hook Location Guideline

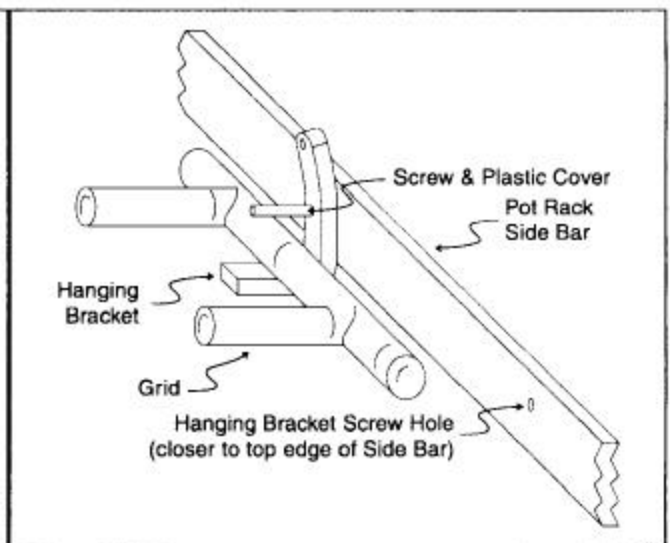

Figure 2
 Hanging Bracket Installation

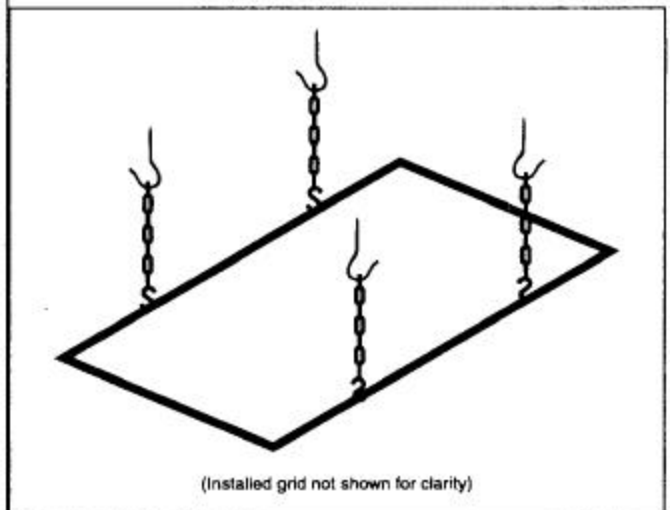

Figure 3
 Hook and Chain Assembly